

ROAD RANGER®















# ISUZU D-MAX

FITTING INSTRUCTION  
H323  
MONTAGEANLEITUNG  
H323

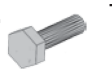

# STÜCKLISTE

## PART LIST

<b>A</b>	 T S C E I 10X25 x 4	<b>M</b>	 M6 x 8
<b>B</b>	 P A R K E R 6X25 x 8	<b>N</b>	 RLB Closings Chiusure RLB Closures RLB x 2
<b>C</b>	 VIPLA Ø80 Plastic Plastica Plastique x 4	<b>O</b>	 ROLL-M x 8
<b>D</b>	 T B C E I 10X25 x 4	<b>P</b>	 M11 brackel Staffe MIT Etriers MIT x 4
<b>E</b>	 TE 6X20 x 8		
<b>F</b>	 Ø 6 x 8		
<b>G</b>	 Ø 6 x 8		
<b>H</b>	 T B C E I 6X25 x 8		
<b>I</b>	 Ø 6 x 8		
<b>L</b>	 Ø 6 x 8		

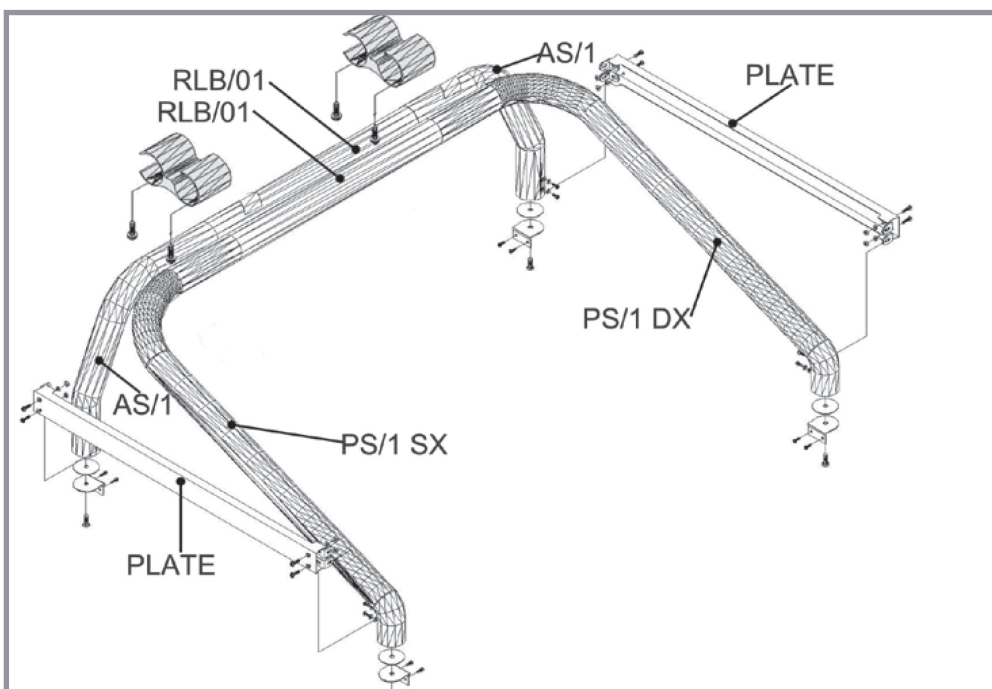

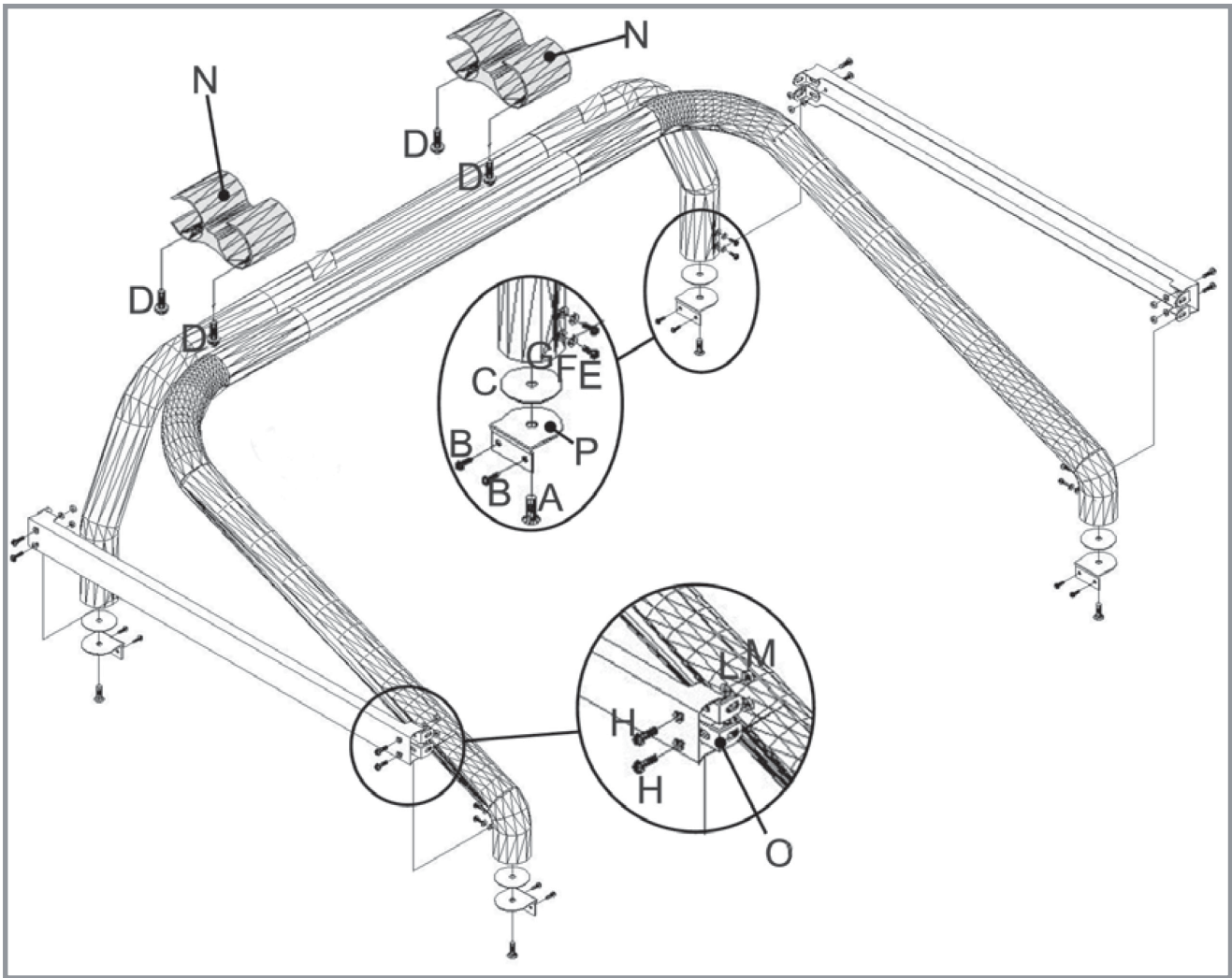

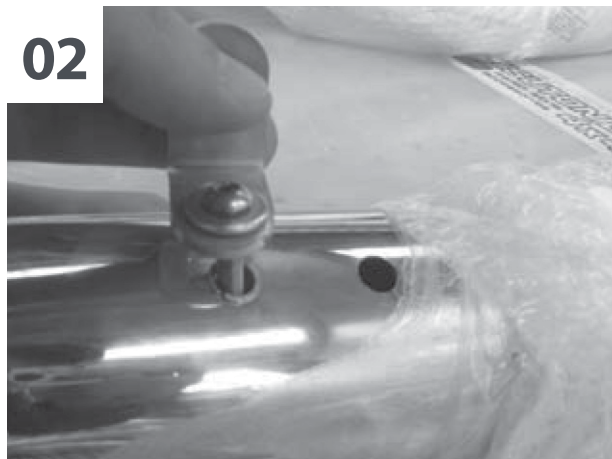
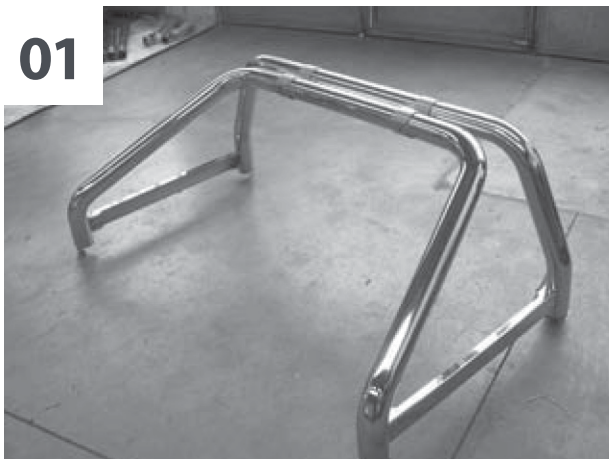

# ROAD RANGER®

## VIELSEITIGKEIT DURCH DESIGN & AUSSTATTUNG VARIETY IN DESIGN & CONFIGURATION

Änderungen vorbehalten. Abbildungen können vom endgültigen Produkt abweichen.  
Sämtliche Abbildungen / Fotos sind Eigentum der  
**Dr. Höhn GmbH**, Künzelsauer Straße 13, 74653 Ingelfingen,  
T: +49 (0) 79 40 92 02 - 0, [info@roadranger.de](mailto:info@roadranger.de)

Subject to change. Pictures may differ from the final product.  
All images / photos property of  
**Dr. Höhn GmbH**, Künzelsauer Straße 13, 74653 Ingelfingen,  
T: +49 (0) 79 40 92 02 - 0, [roadranger@hoehn.de](mailto:roadranger@hoehn.de)

Für weitere und immer aktuelle Informationen können Sie uns gerne unter  
[www.roadranger.de](http://www.roadranger.de) besuchen.

For more details and updated information please visit [www.roadranger.de](http://www.roadranger.de).

Ihr Road Ranger Team  
Your Road Ranger Team

**GESTALTUNG UND GRAFIKDESIGN**  
GRAPHIC DESIGN

christina richter visuelle kommunikation, stuttgart  
[www.christina-richter.com](http://www.christina-richter.com)