

# **Anbauanleitung Seilwindenanbausatz** ***Fitting instruction winch mounting kit*** **Toyota Hilux ab Bj.2005**

Best.-Nr.: 16 - 5820

AL: 1177 – 02



**Hier sehen sie den fertig montierten Seilwindenanbausatz.**  
**Bevor sie mit der Montage beginnen, lesen sie bitte diese Anleitung**  
**und das Benutzerhandbuch der Seilwinde gut durch.**

### **Achtung:**

Bei Fahrten im öffentlichen Straßenverkehr muß das Rollenseilfenster mit  
der Kunststoffabdeckung Best.nr.: **15 – 899** abgedeckt werden.

*Before you start fitting, please read and understand this instruction manual  
and the owners manual of the winch.*

# Stückliste / Parts list

## Seilwindenanbausatz/ winch mounting kit Toyota Hilux ab Bj.2005

Best.nr.: 16 - 5820

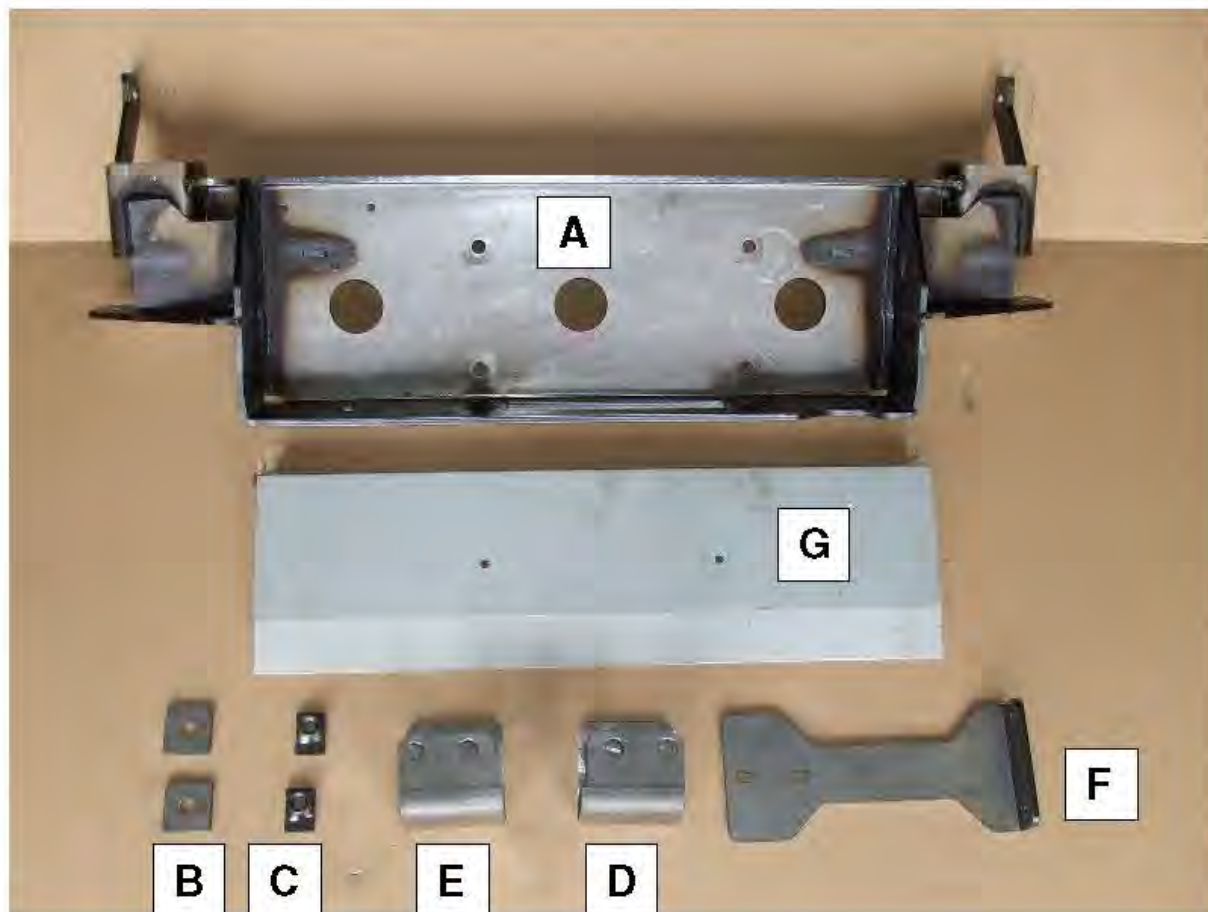

1 x Seilwindenkassette ( A )

2 x Distanzplatte ( B )

2 x Gewindeplatte ( C )

1 x U – Klemme rechts ( D )

1 x U – Klemme links ( E )

1 x Schaltkastenhalter ( F )

1 x Schablone ( G )

1 x Steckdose 1 - 39744

1 x Kunststoffabdeckung 15 – 899

1 x Anbauanleitung AL 1177

1 x Gutachten

4 x Schraube M 12 x 110  
2 x Schraube M 12 x 1,25 x 30  
2 x Schraube M 12 x 30  
2 x U – Scheibe M 12 x 30 x 3  
10 x U – Scheibe M 12  
8 x Federring M 12  
4 x Mutter M 12

2 x Schraube M 10 x 25  
4 x U – Scheibe M 10 x 30 x 3  
2 x U – Scheibe M 10  
2 x Federring M 10

4 x Schraube M 6 x 20  
4 x Federring M 6  
2 x U – Scheibe M 6  
2 x U – Scheibe M 6 x 20  
2 x Mutter M 6

2 x Schraube M 5 x 20  
4 x U – Scheibe M 5  
2 x Federring M 5  
2 x Mutter M 5



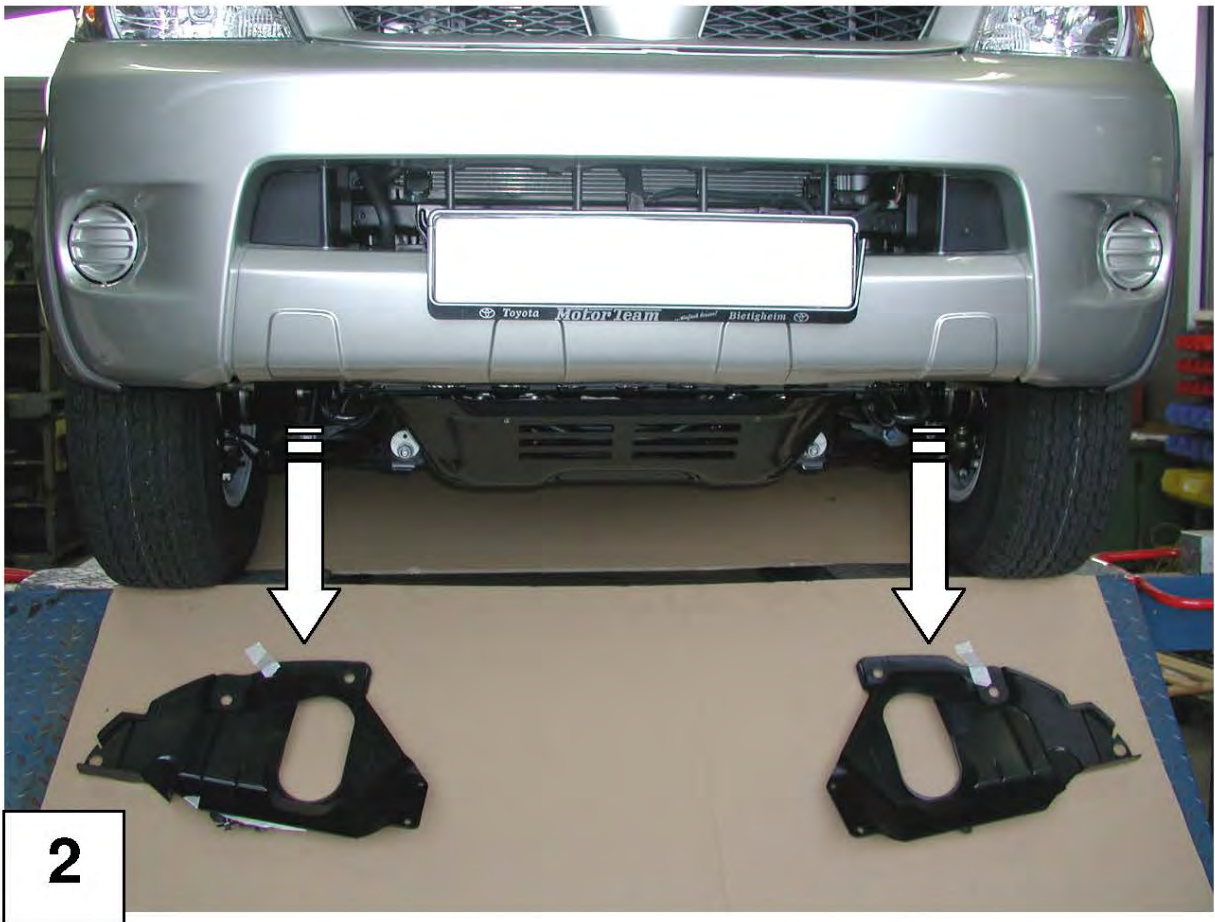



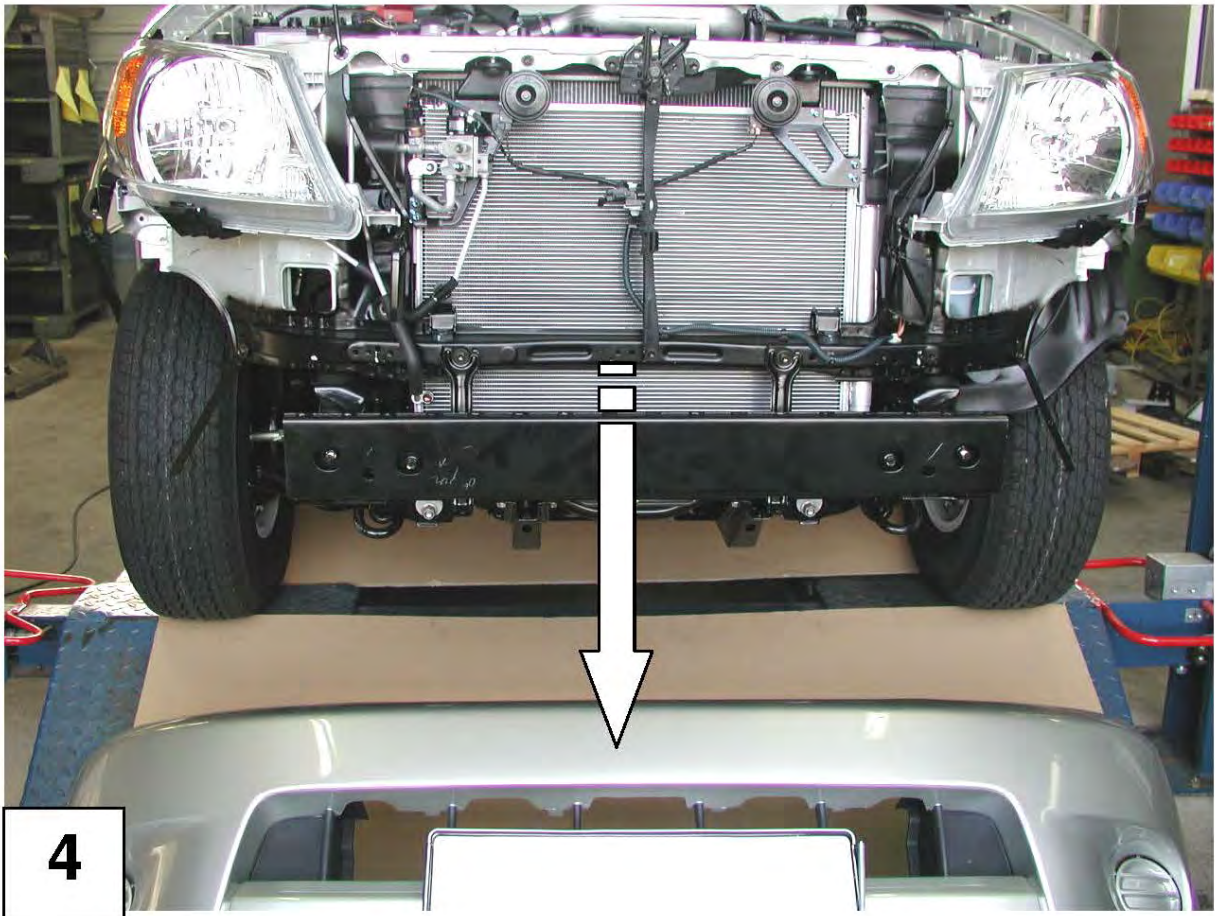



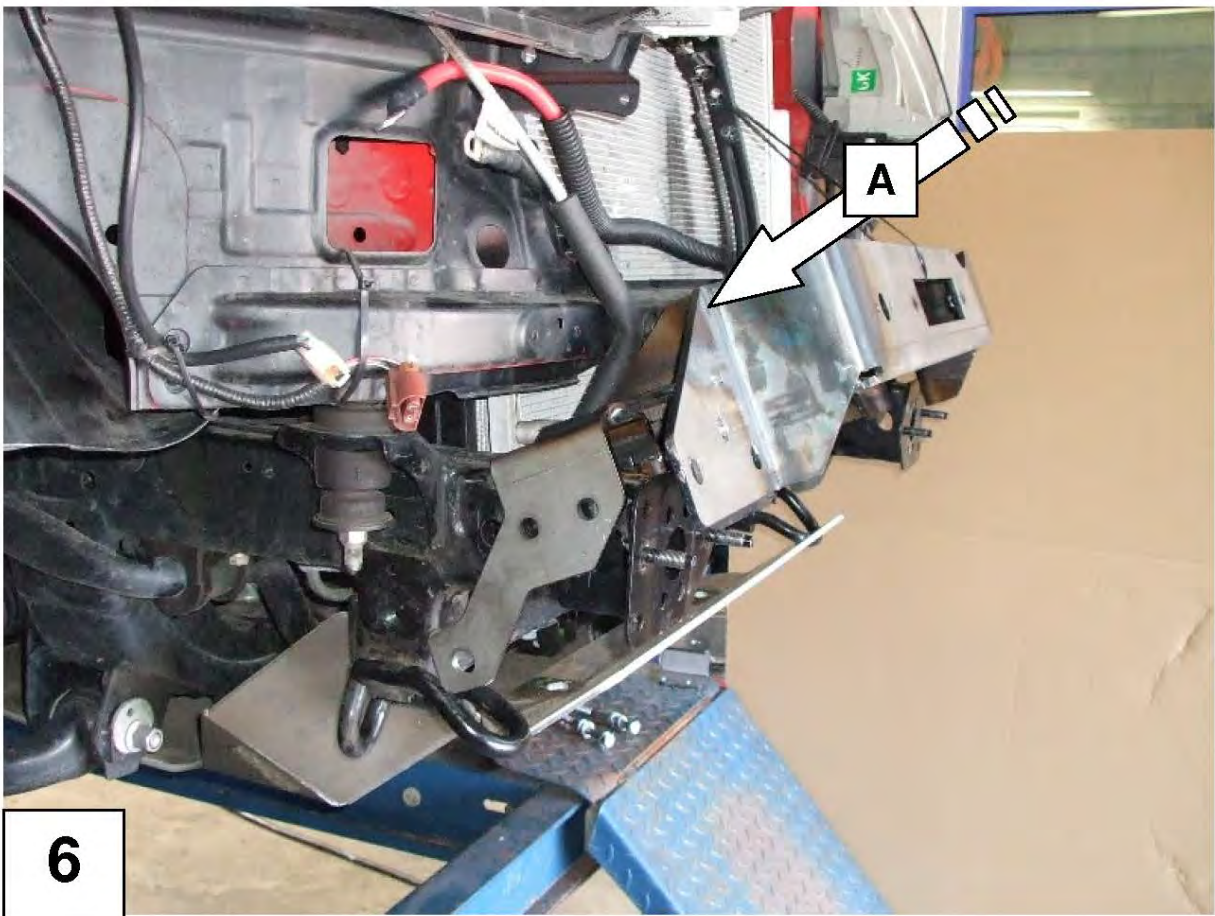
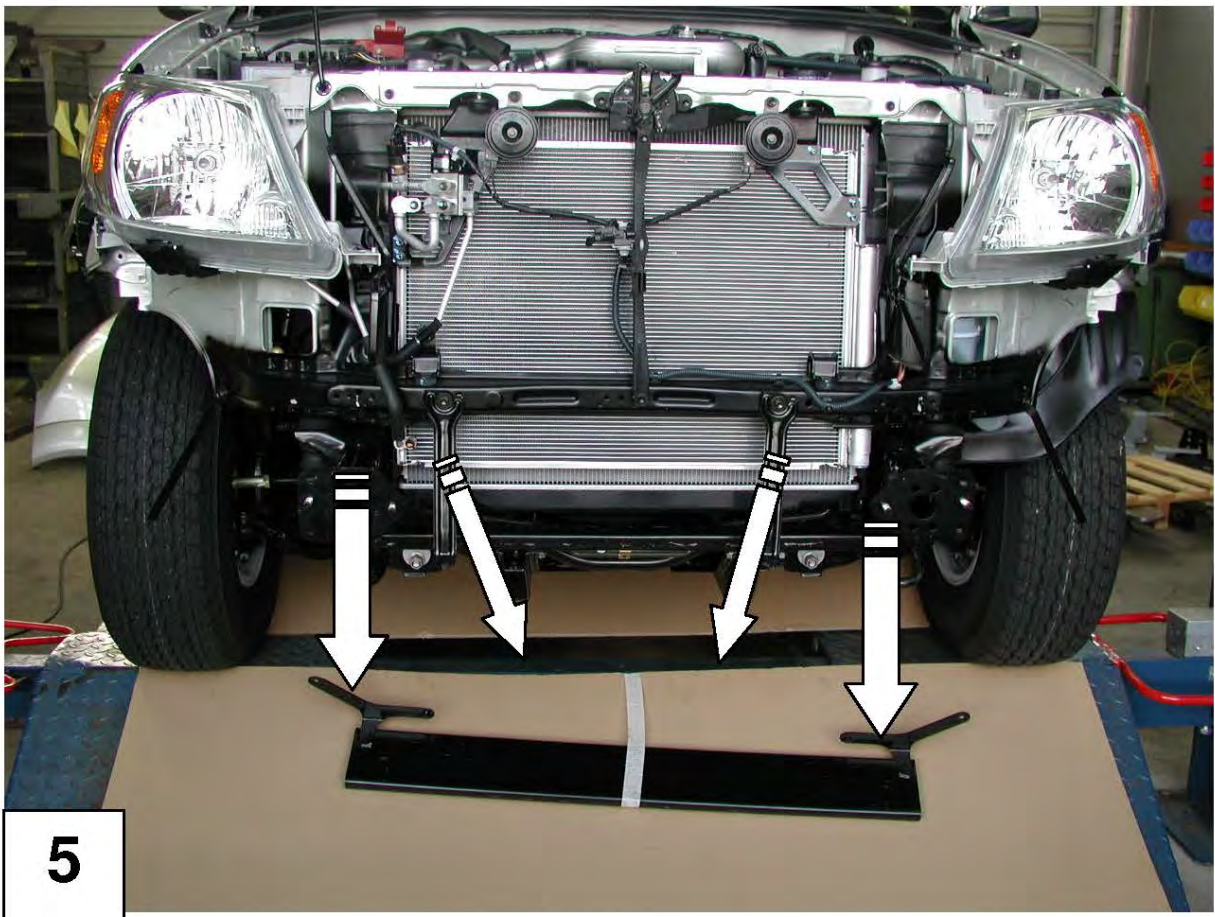



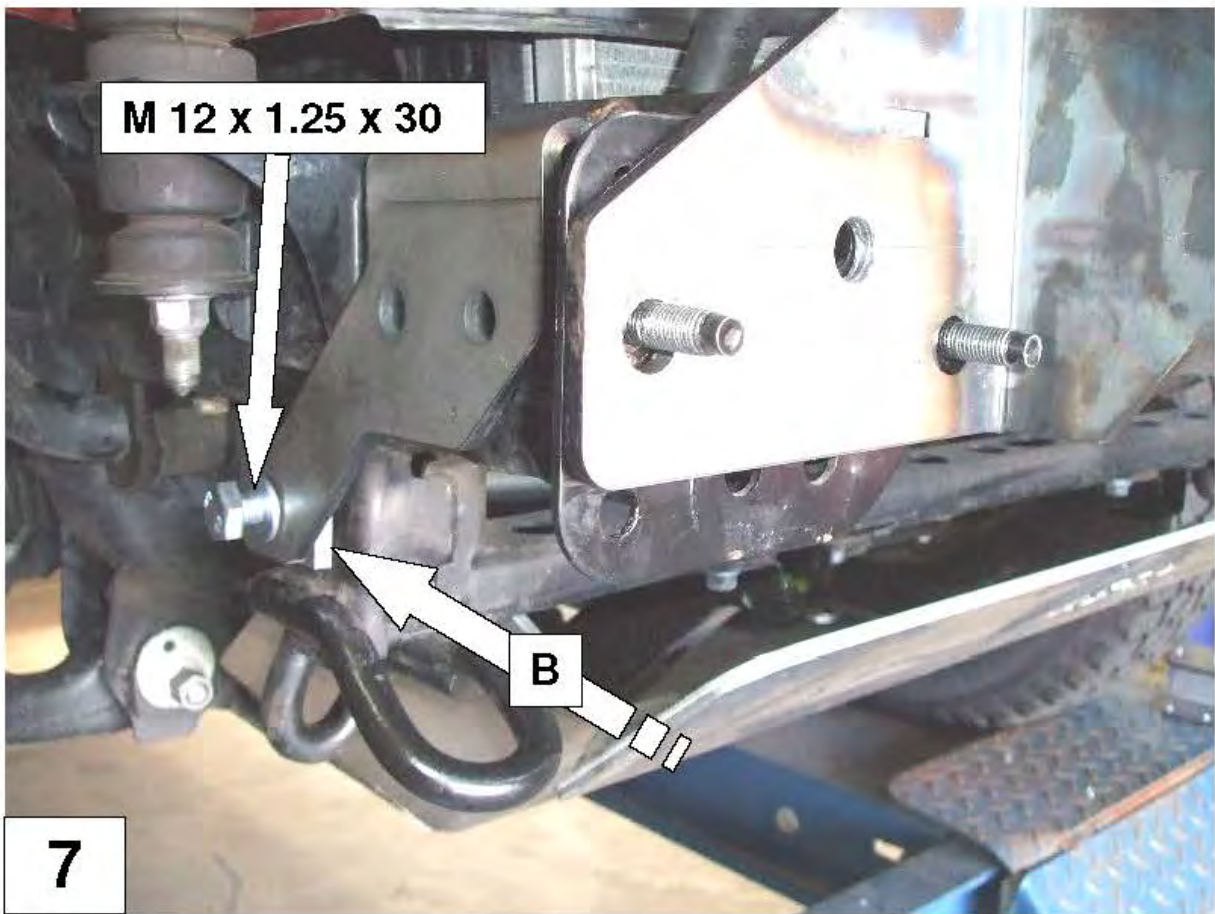



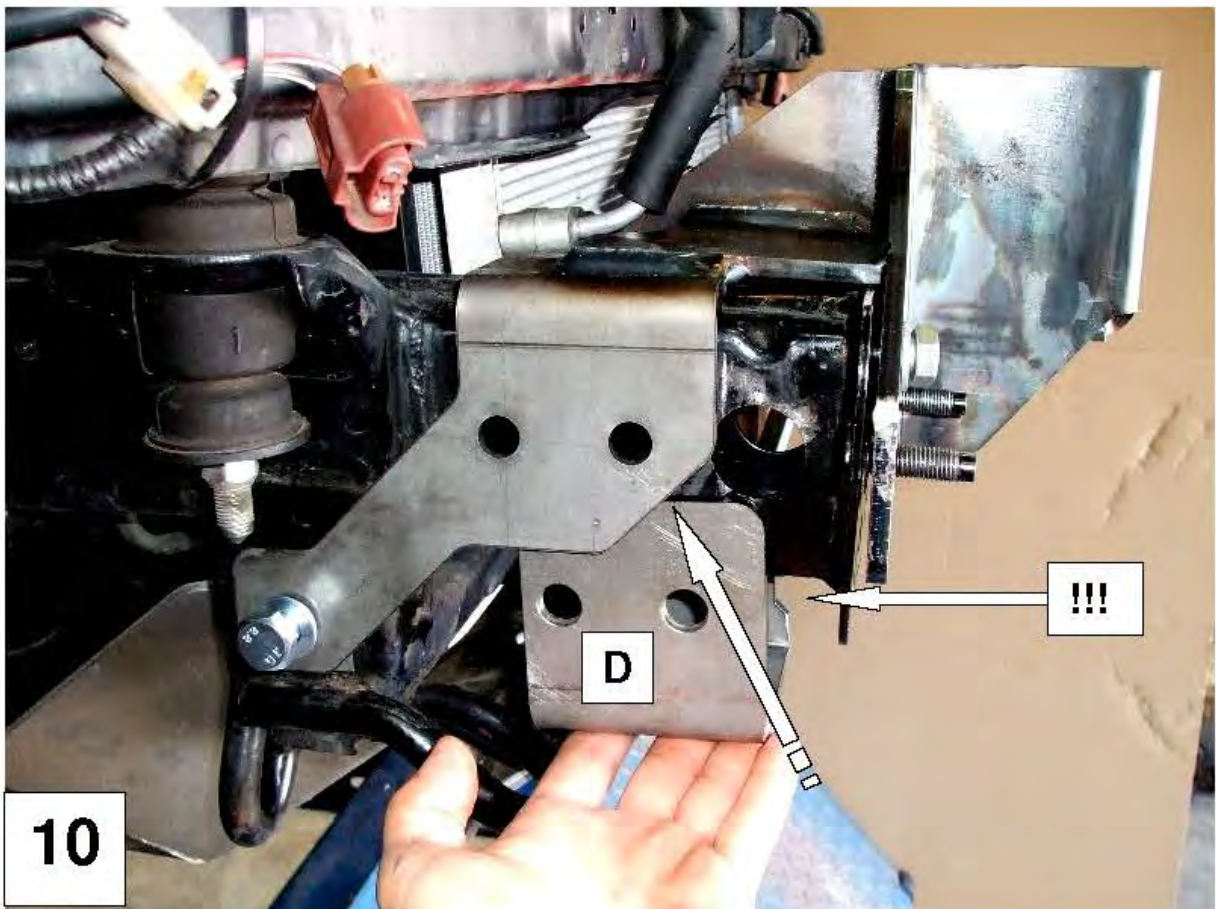
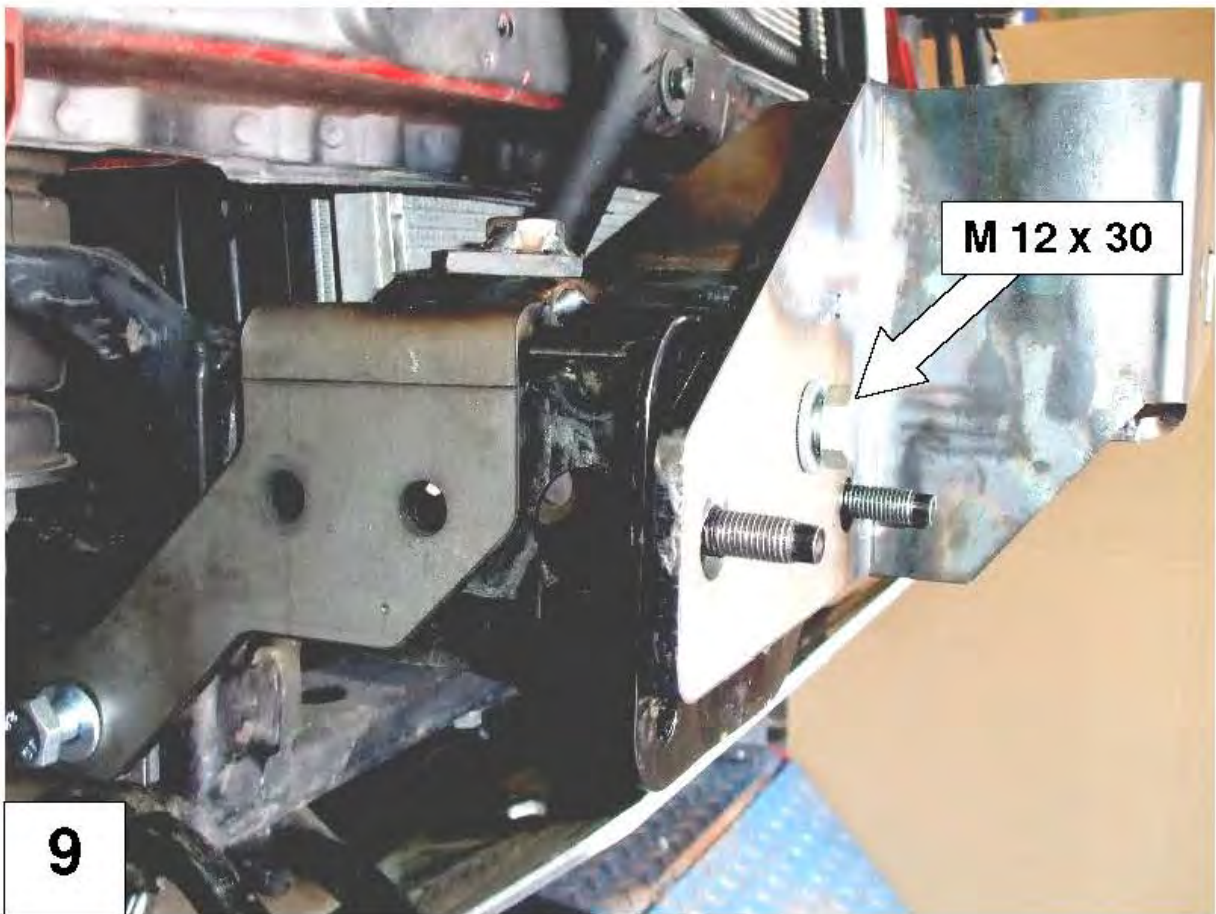



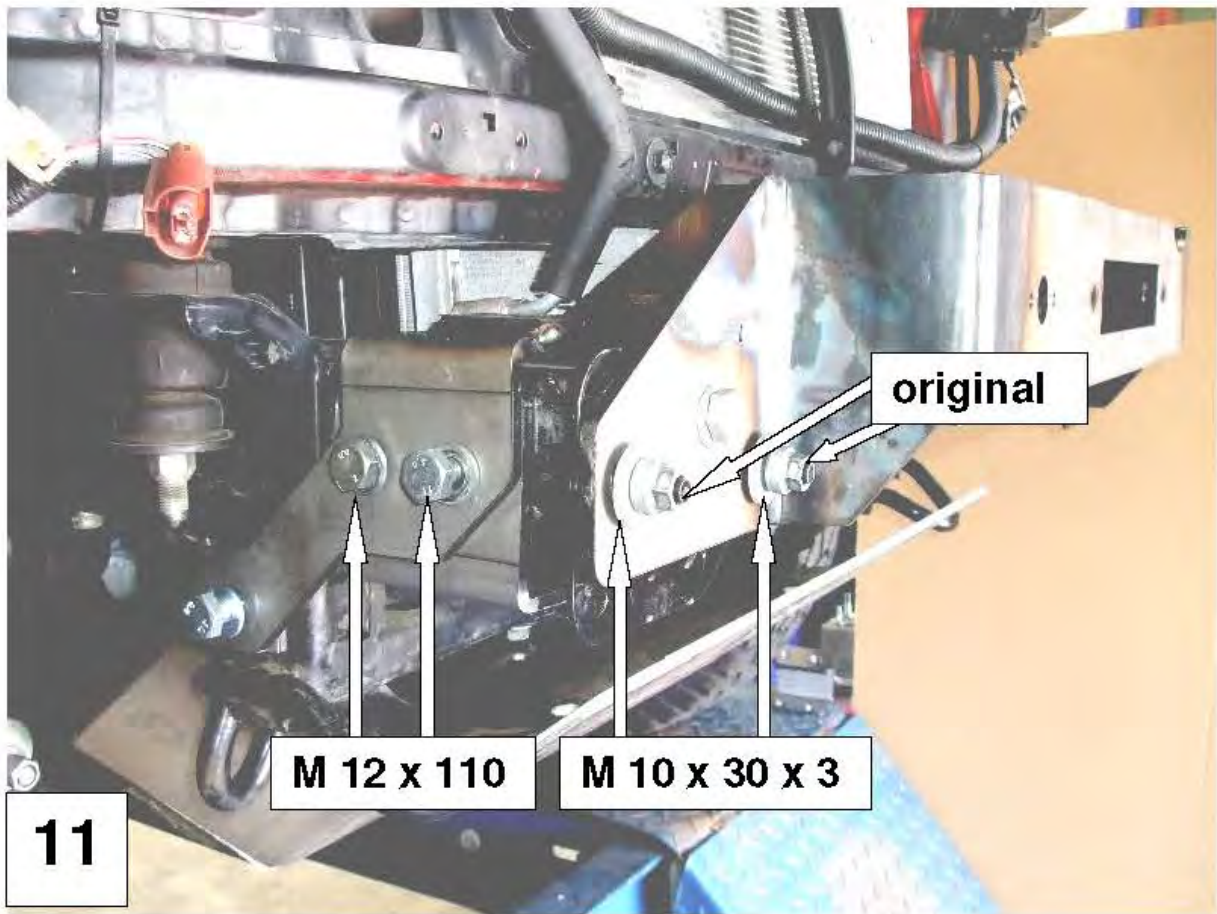



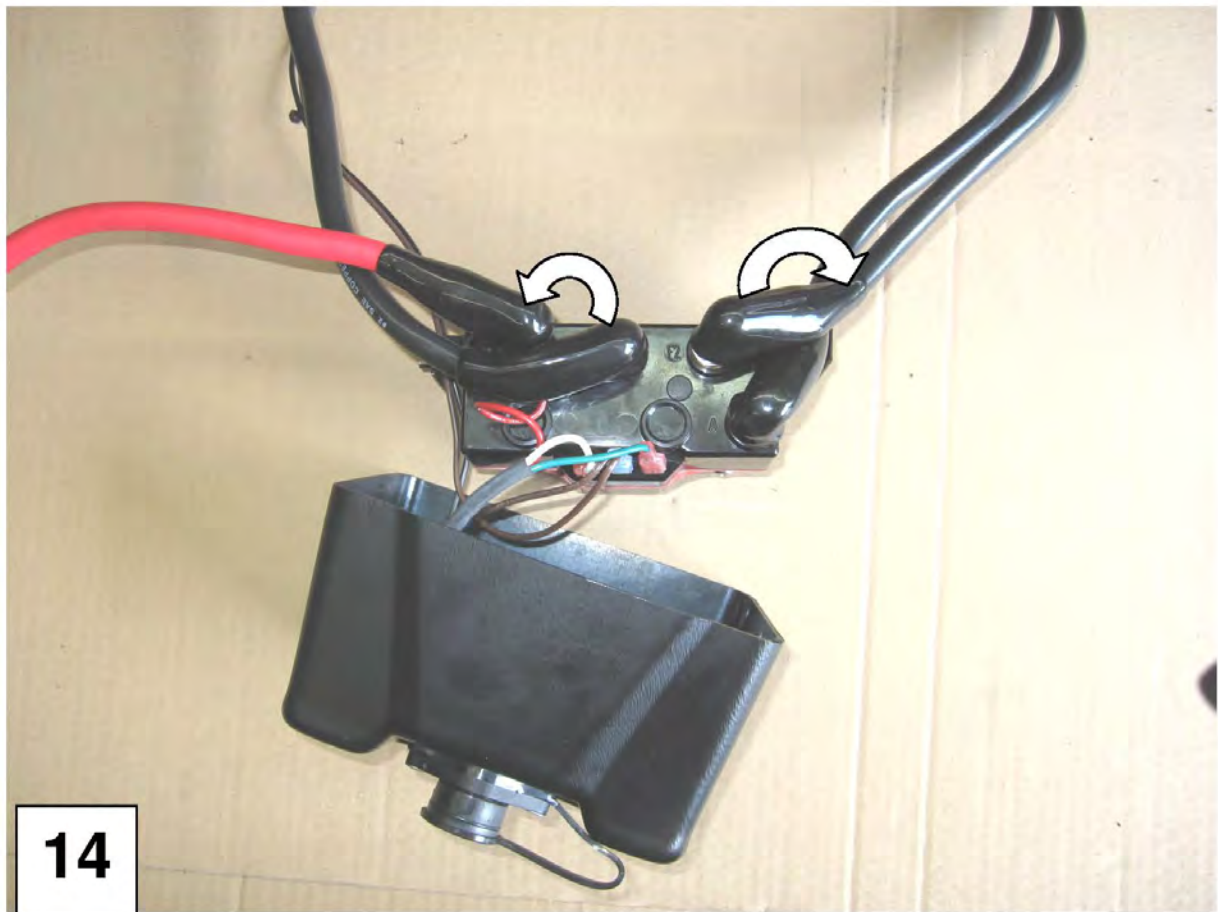
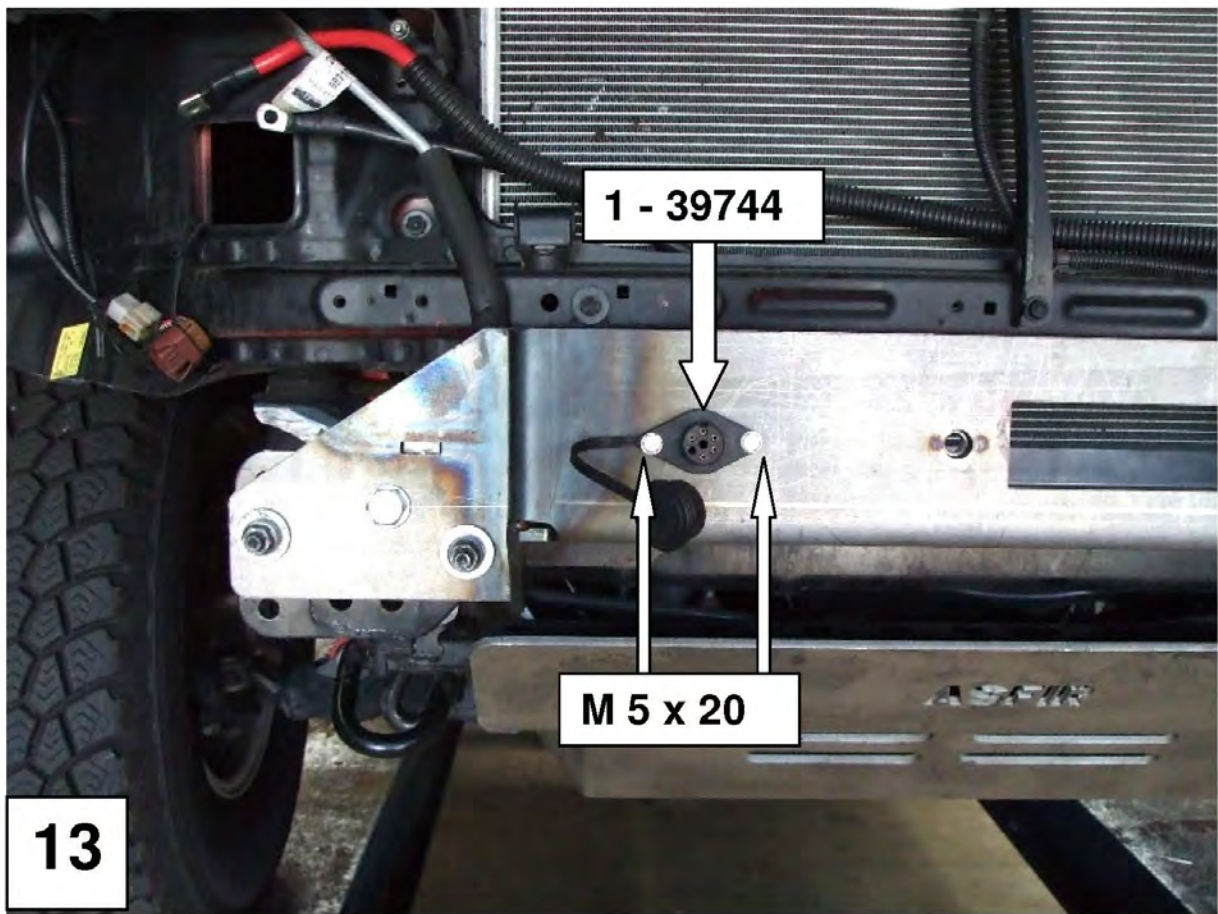



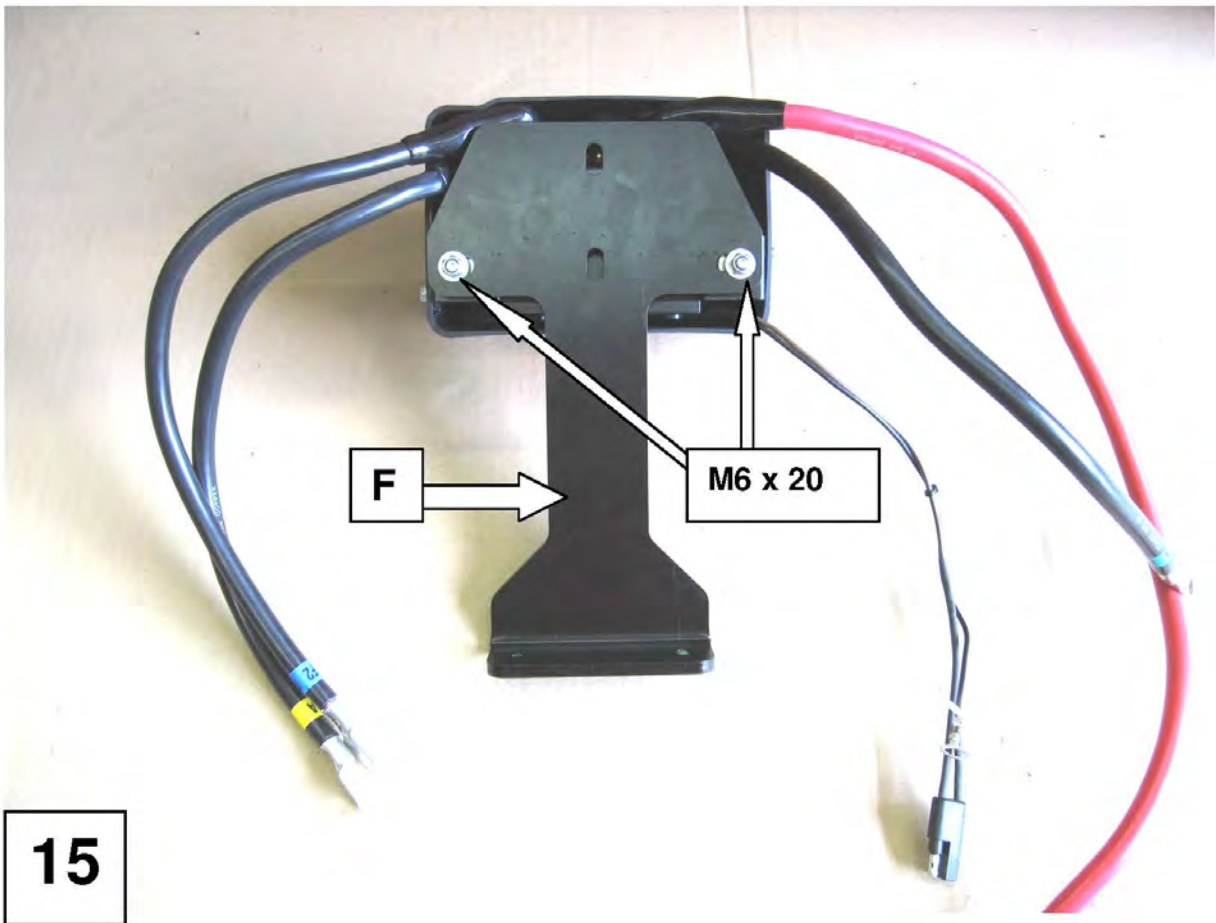

15



16



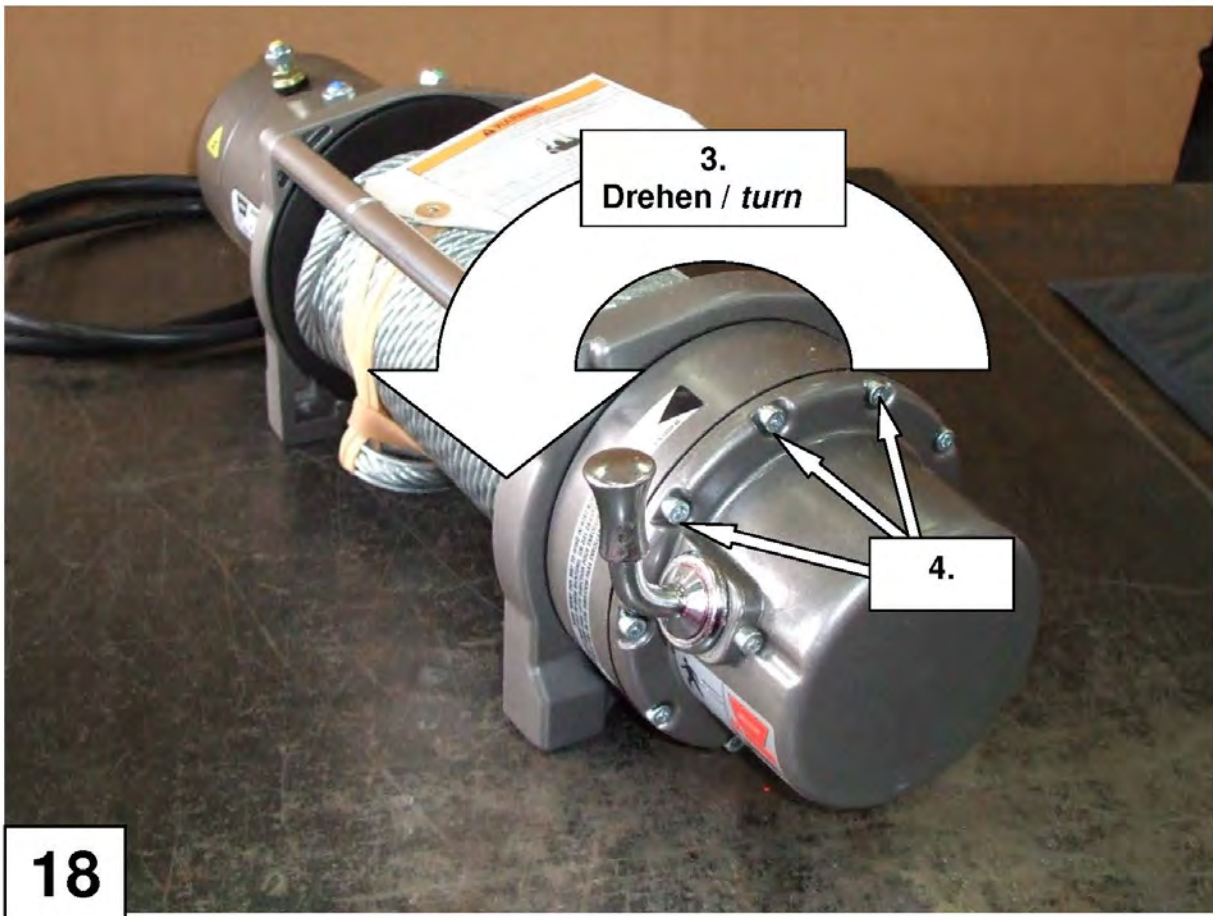
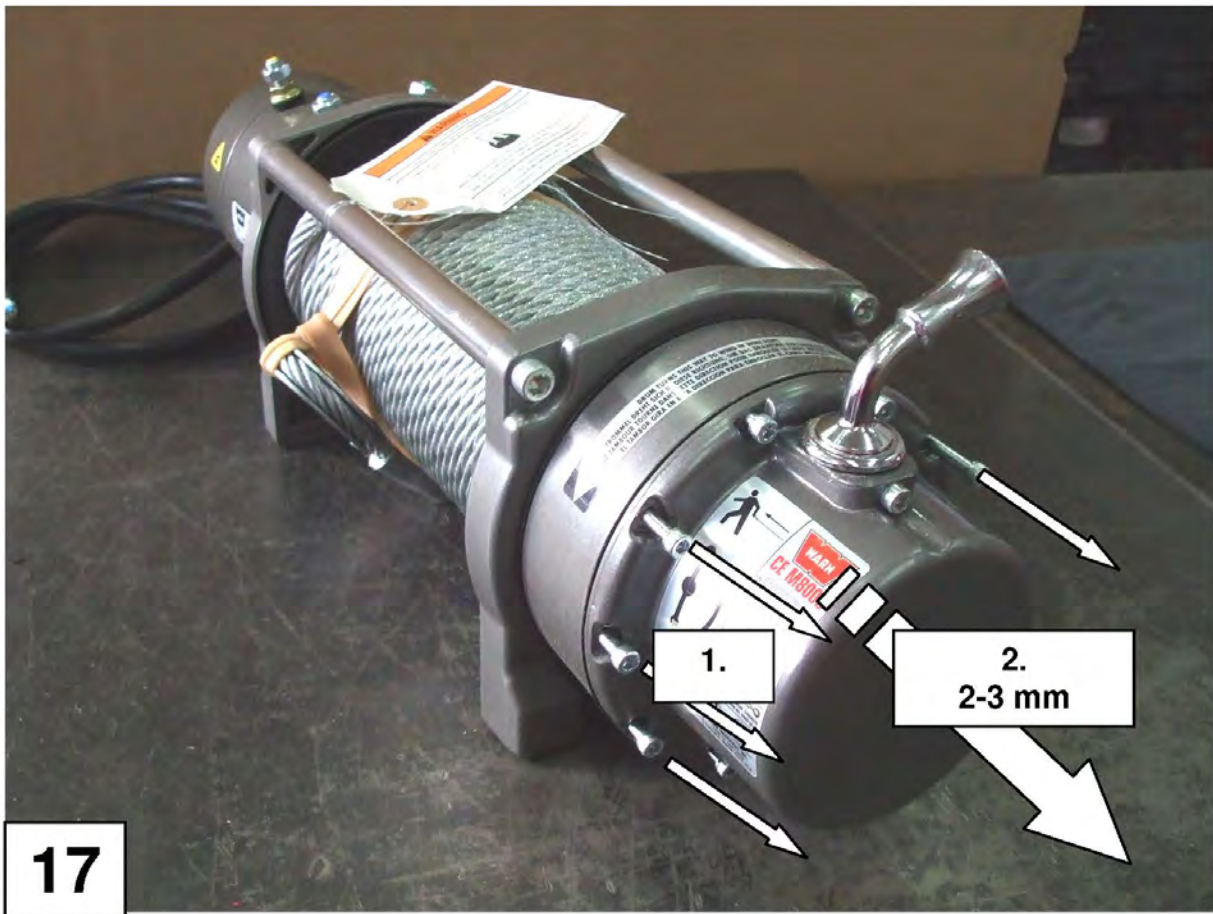



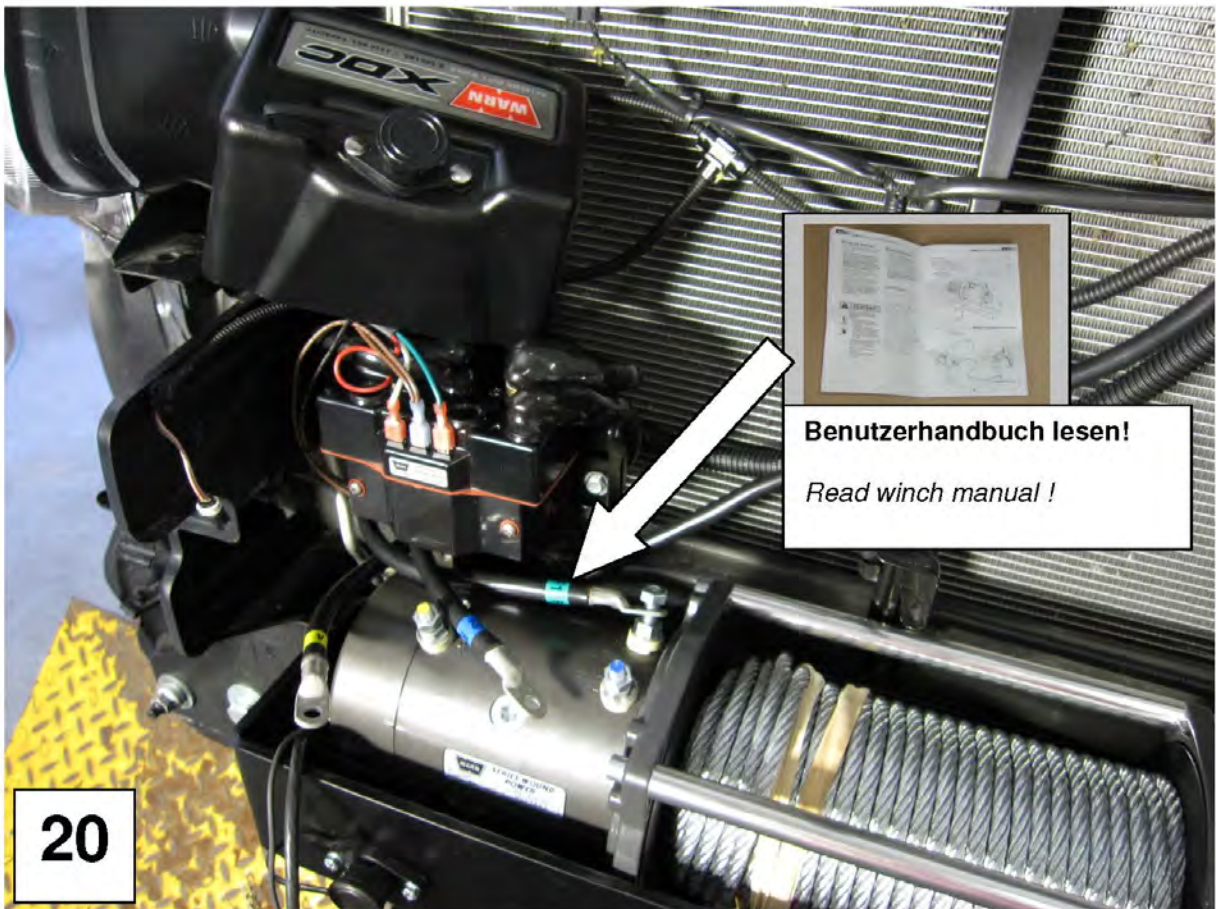
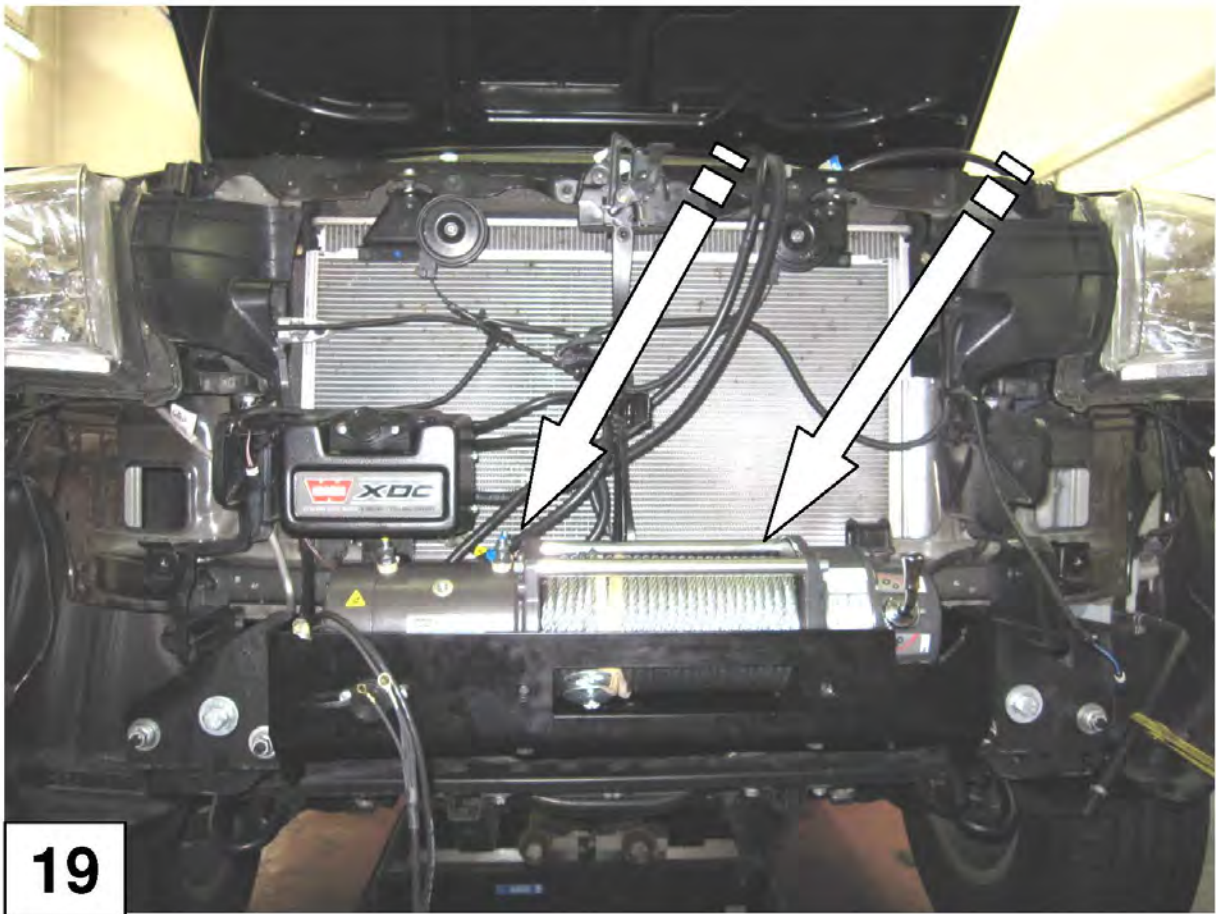





21

**Schließen sie die Steckdose im Schaltkasten an.**  
*Connect socket to the contactor !*

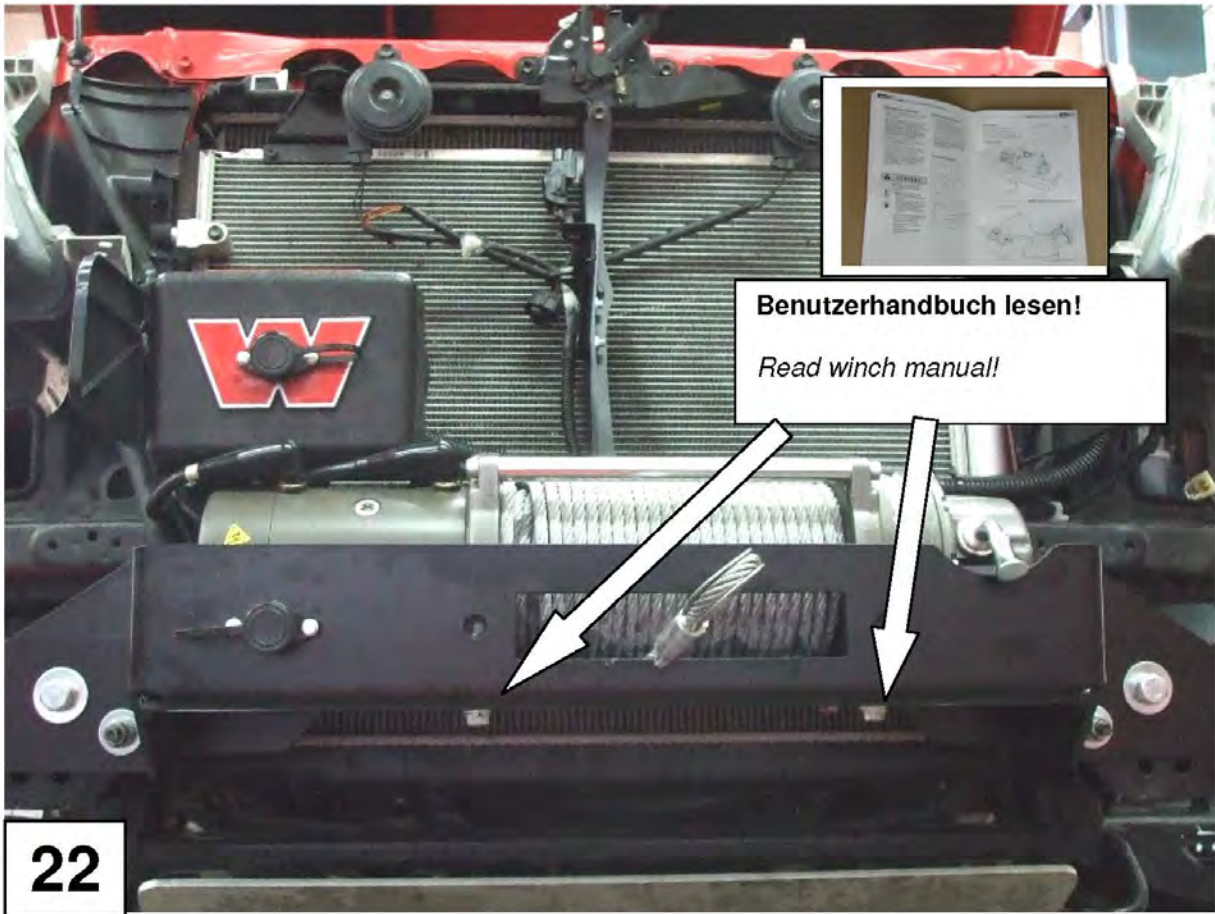

22

**Benutzerhandbuch lesen!**  
*Read winch manual!*



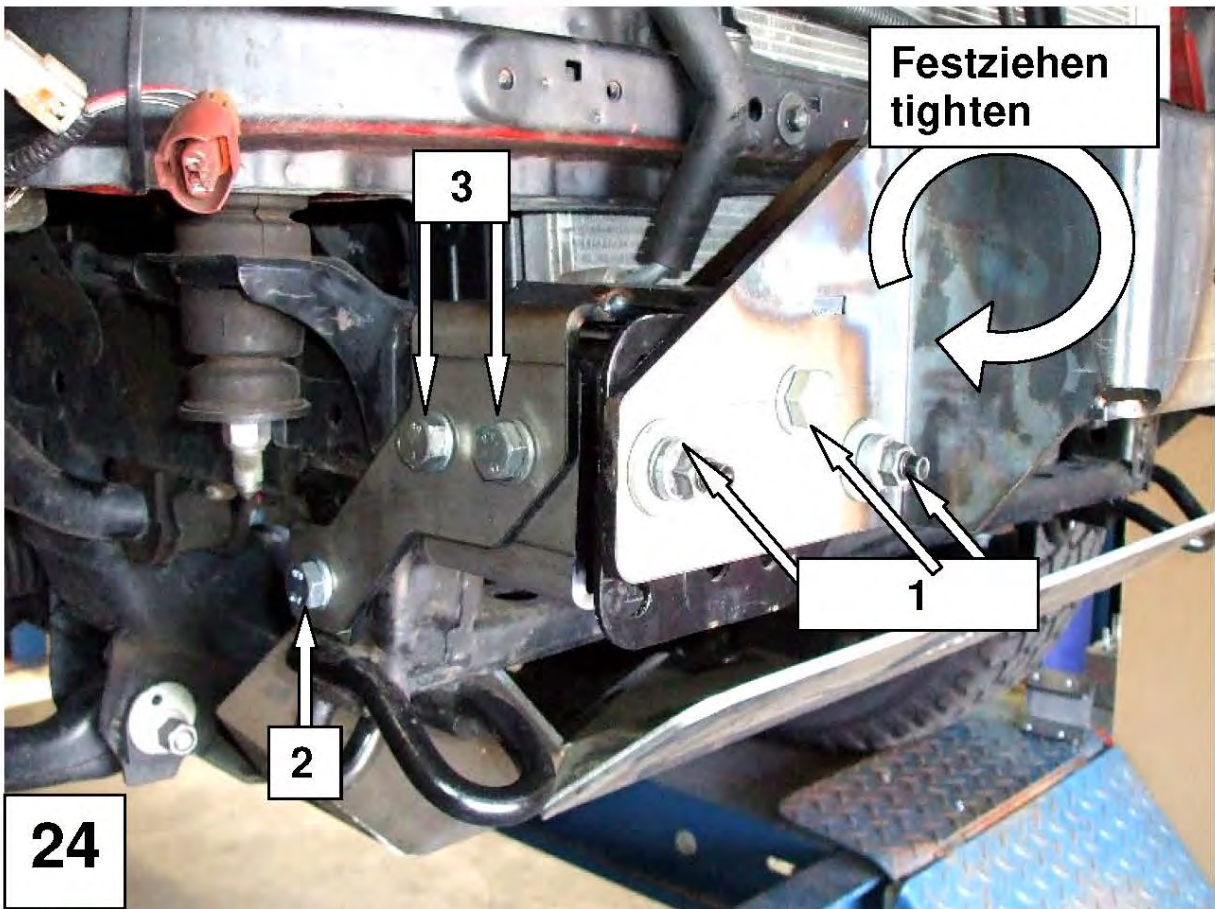



Für Modelle vor 2011 benutzen sie Schablone ( G )

*For models before 2011 use template ( G )*



25

Für Modelle vor 2011 benutzen sie Schablone ( G )

*For models before 2011 use template ( G )*

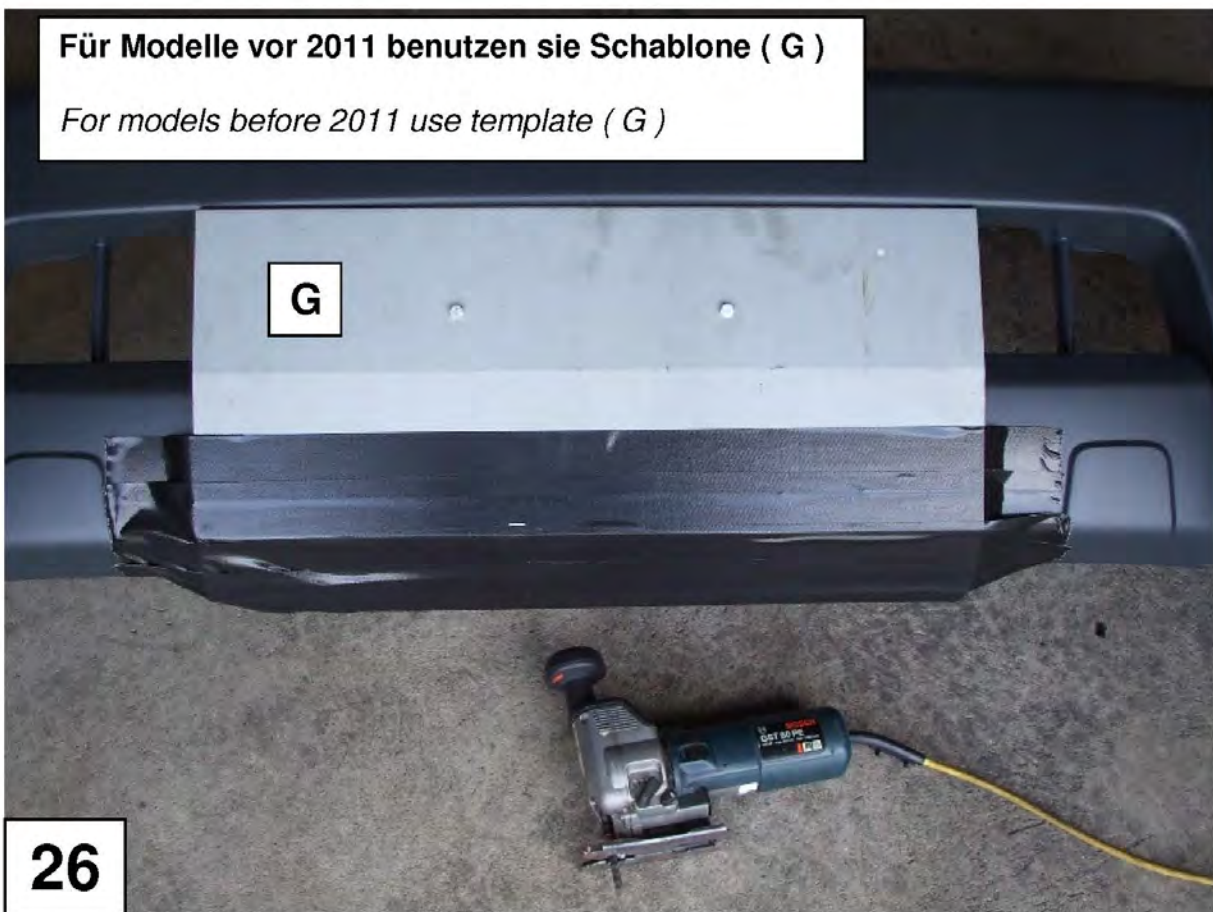

26



**Modelle bis 2011 !**  
*models up to 2011 !*



**27**

**Modelle von 2011 an !**  
*2011 on models !*



**28**



Modelle von 2011 an !  
2011 on models !

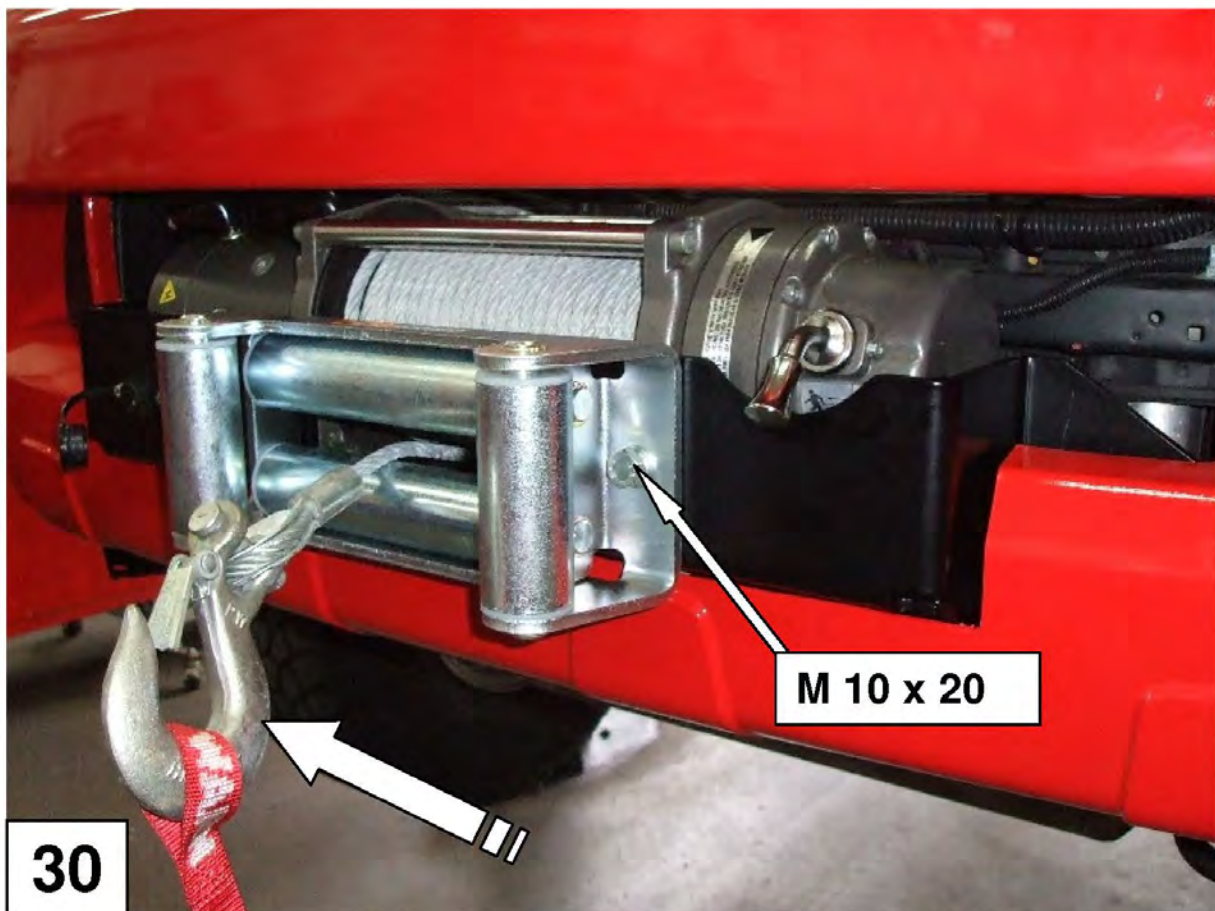
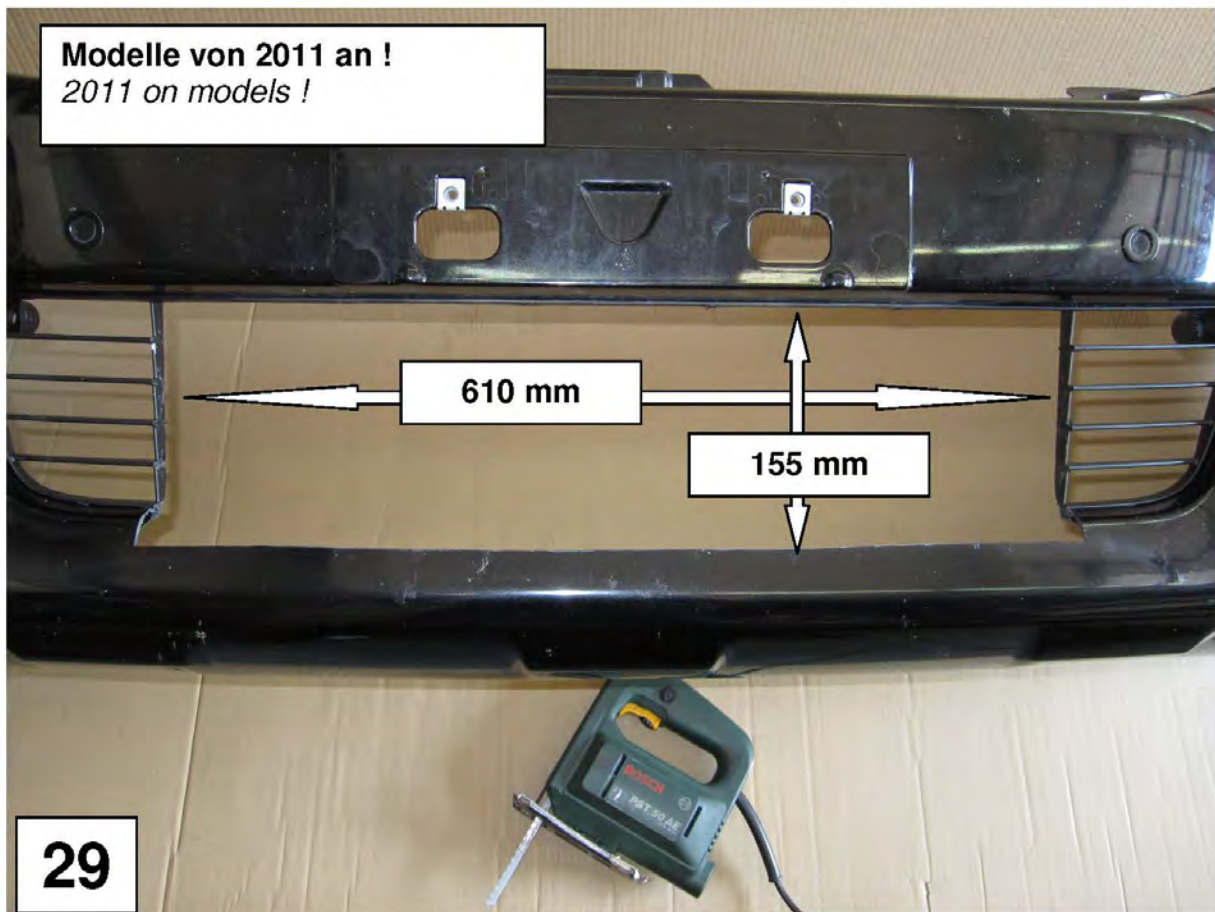



**Modelle bis 2011 !**  
*models up to 2011 !*



**31**

**Modelle von 2011 an !**  
*2011 on models !*



**32**