

F.

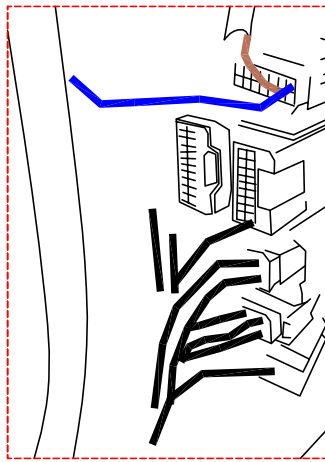

ZENTRALVERRIEGLUNG SCHLIESSEN
BLAU / (BLUE)

BRAUN /
(BROWN)

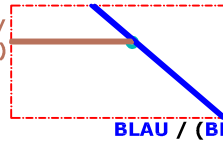

BLAU / (BLUE)

PLUG NO 231
PIN 9



x1

I



II

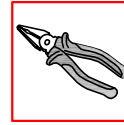

III



G.

a)

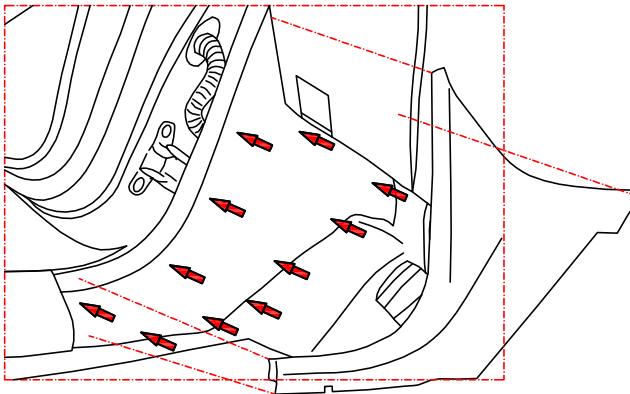

b)

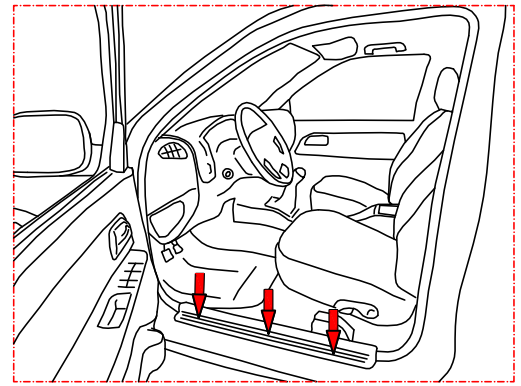

19.

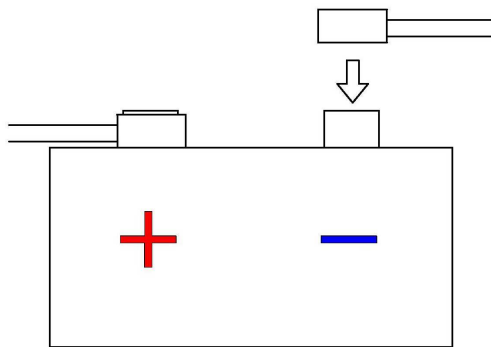

1000km

max.7Nm

max.3Nm

max.7Nm

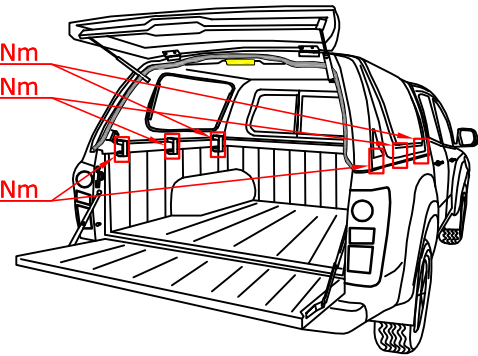

D

ACHTUNG!

Etwaige Gewährleistungsansprüche bzw. Schadenersatzansprüche aller Art können von uns nur bei einer ordnungsgemäßen und der Anleitung entsprechenden Montage in einer Fachwerkstatt berücksichtigt werden. Wir weisen ausdrücklich daraufhin hin, dass eine unsachgemäße und nicht in einer Fachwerkstatt durchgeführte Montage einen Verzicht auf die Geltendmachung jeglicher Art insbesondere, auch aus dem Titel des Produkthaftpflichtrechtes bewirkt. Für die Befestigung sind ausschließlich die beiliegenden Befestigungsteile zu verwenden.

PL

UWAGA!

Reklamacje oraz uznanie gwarancji będą uwzględniane pod warunkiem montowania nadbudowy zgodnie z niniejszą instrukcją w przystosowanym do tego celu salonie samochodowym. Zwracamy uwagę na to, że niefachowy montaż nadbudowy, nie przeprowadzony w salonie samochodowym skutkuje rezygnacją z praw do gwarancji. Zwracamy również uwagę na używanie części z paczki montażowej załączonej do każdej nadbudowy.

GB

ATTENTION!

Guarantee claims/compensation claims of all kinds can only be entertained by us if assembly has been carried out properly and in accordance with instructions in a specialist workshop. We would expressly point out that any improper assembly which is not carried out in specialist workshop will result in the renunciation of the enforcement of compensation claims of any kind, in particular those arising by virtue of the product liability law. For the purpose of fixing, please use the attached fixing parts only.

DR. HÖHN

Die Formel für Fahrvergnügen

Dr. Höhn GmbH

Künzelsauer Str. 13

74653 Ingelfingen

Germany

Telefon : +49 7940 9202 41

Fax : +49 7940 9202 45

www.hoehn.de

Email: roadranger@hoehn.pl

MKT
Car-Technik

MKT Car-Technik Sp. z o.o.

ul. Spokojna 5

14-100 Ostróda

Poland

Telefon: +48 89-646-13-23

Fax: +48 89-646-13-24

Email: info.mkt@hoehn.pl

PROTECTORS INSTALLATION

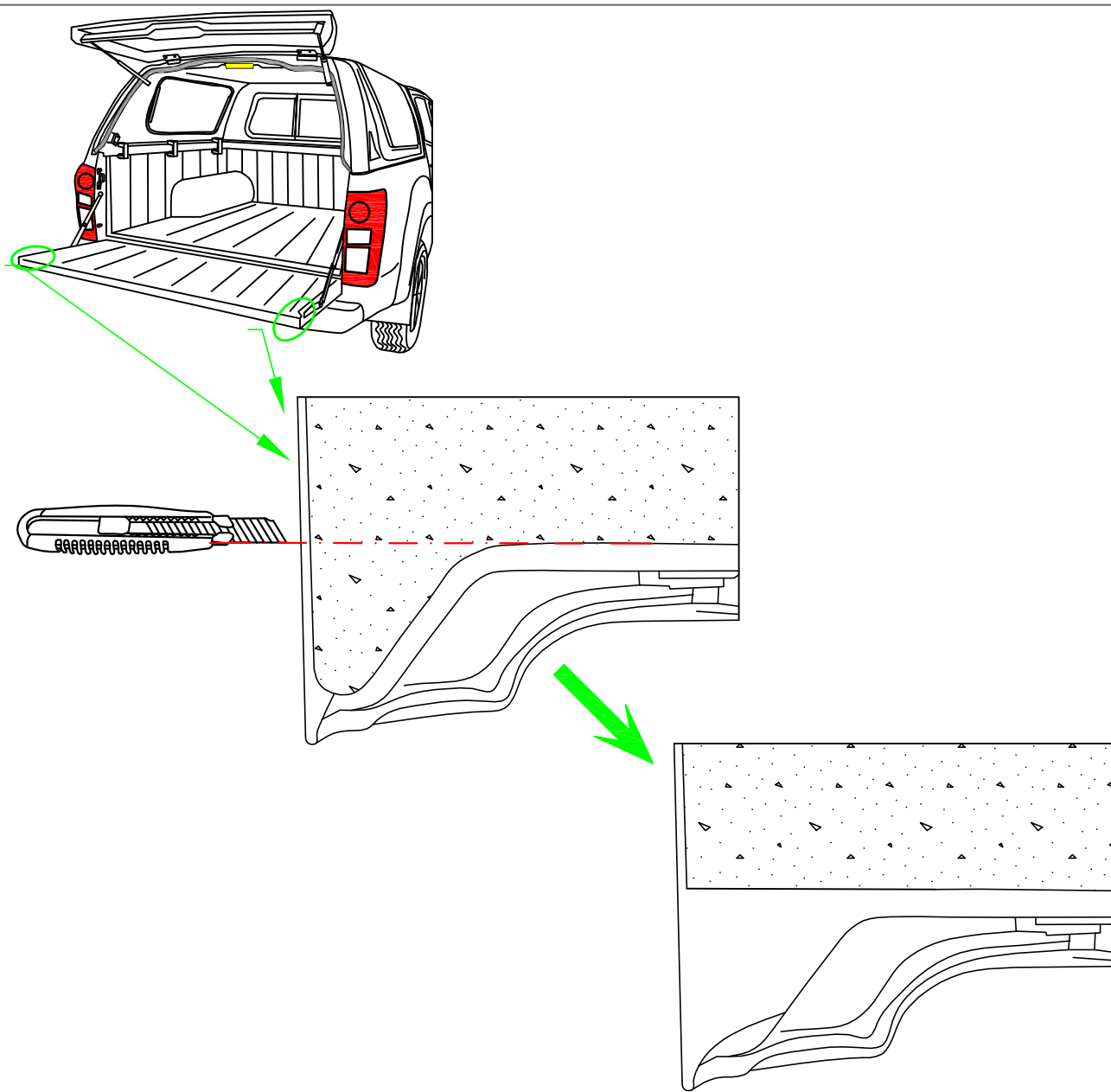
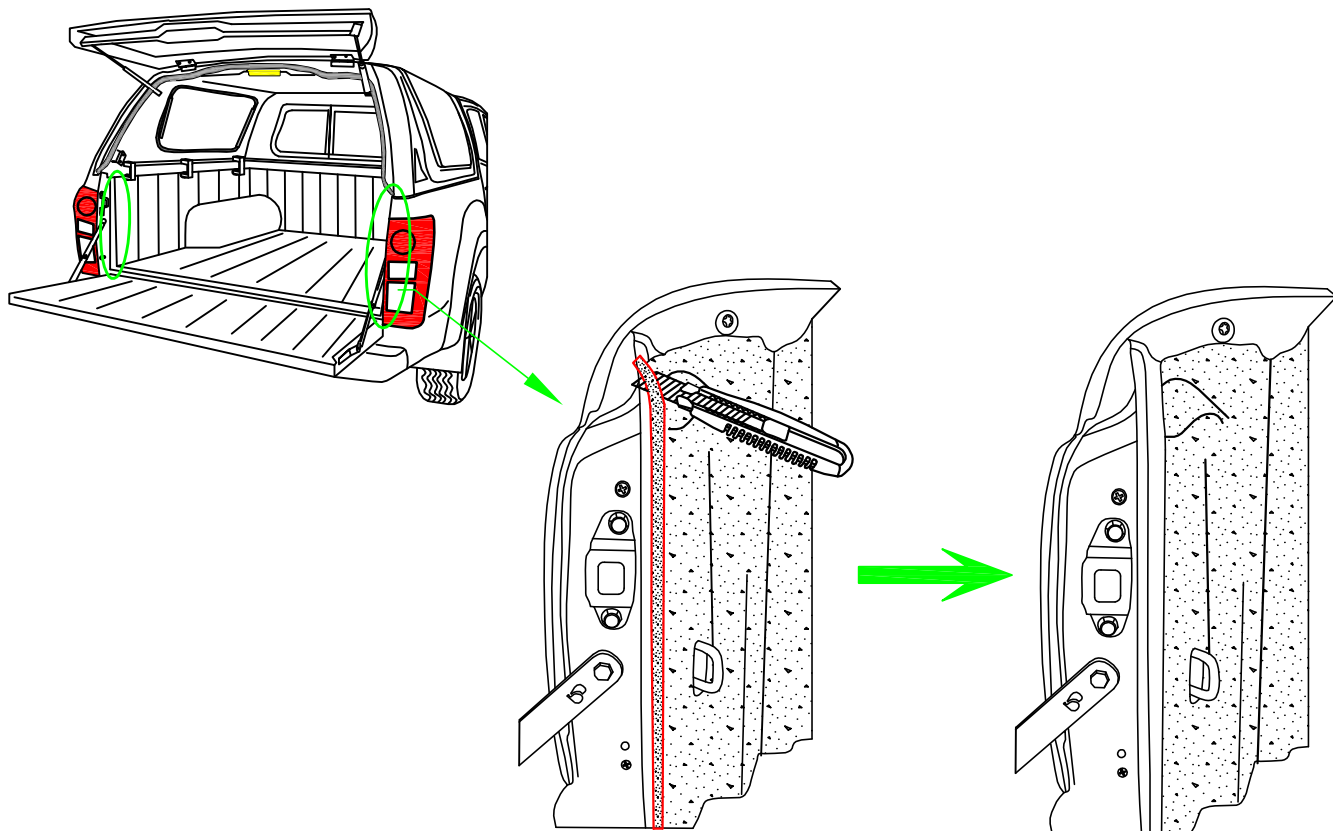

Montageanleitung >> Инструкция по установке >>

Montageanleitung >> Инструкция по установке >> Montageanleitung >> Instruções de Montagem

Installation instruction >> Instructions de montage >> Istruzioni di montaggio >> Instruções de montagem >> Montageanvisning >> Instruções de Montagem

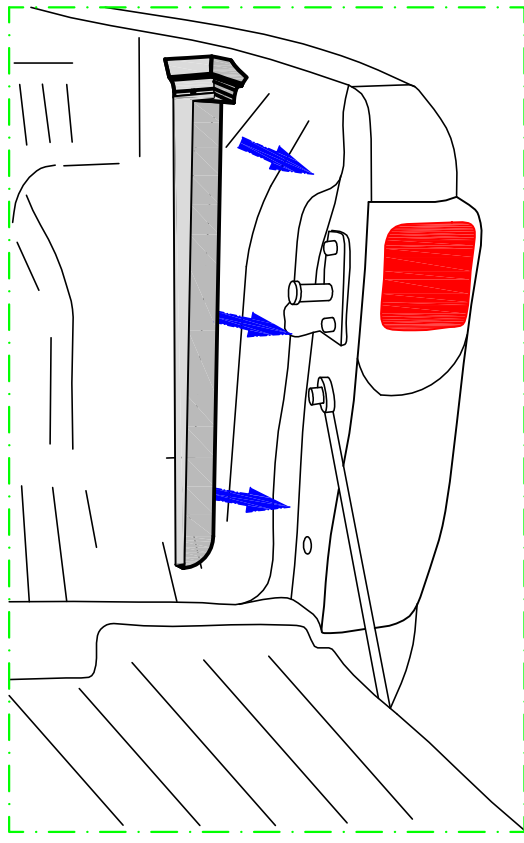
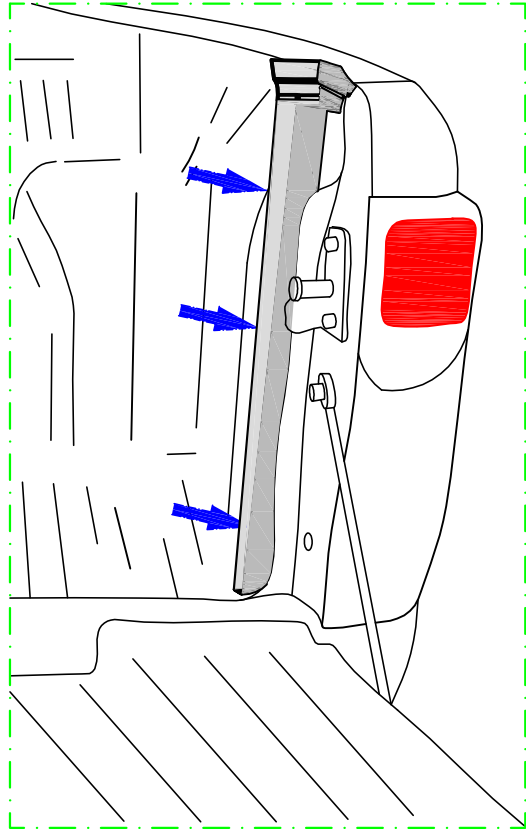
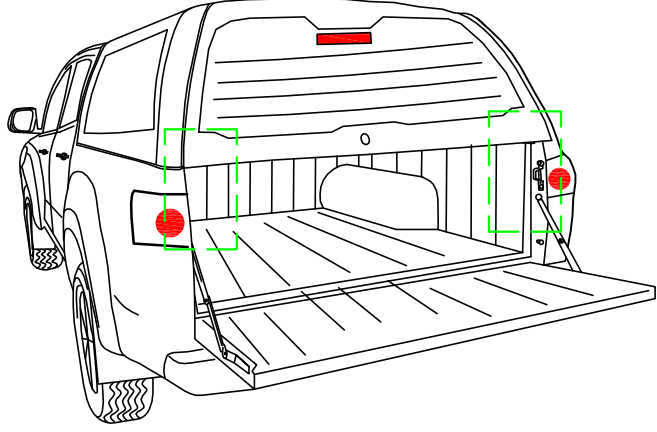
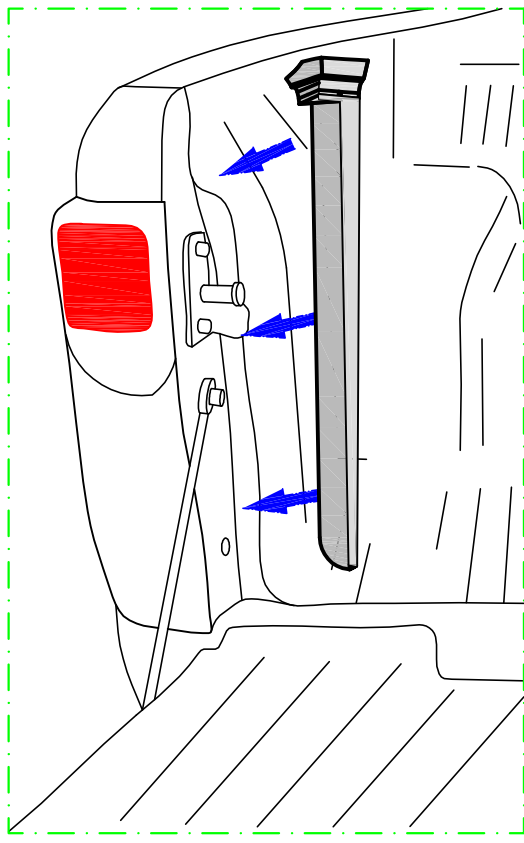
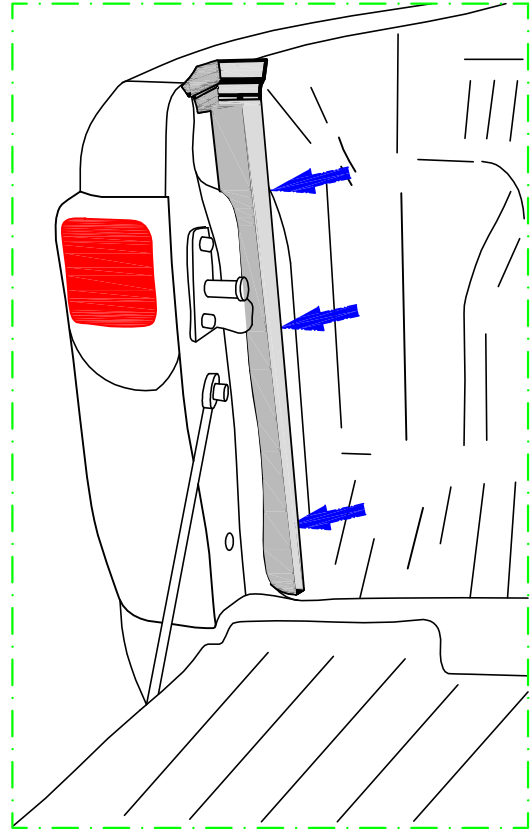

I

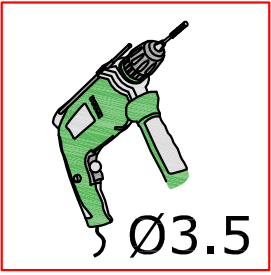

II

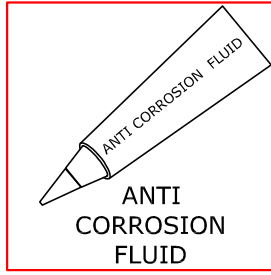

III

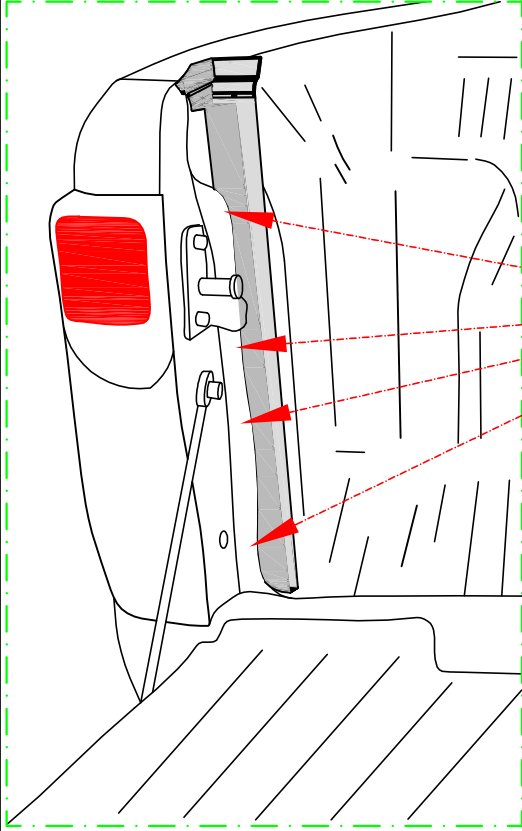
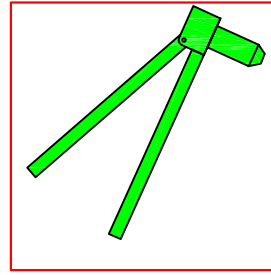

I

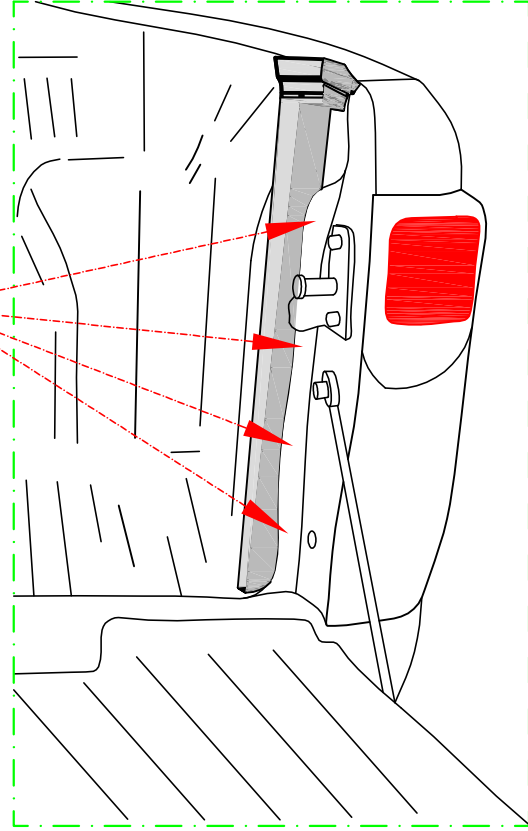
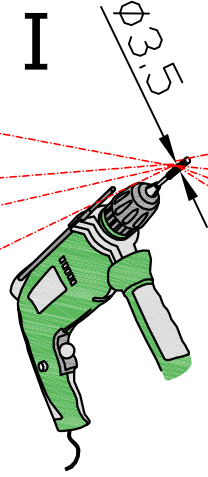

II

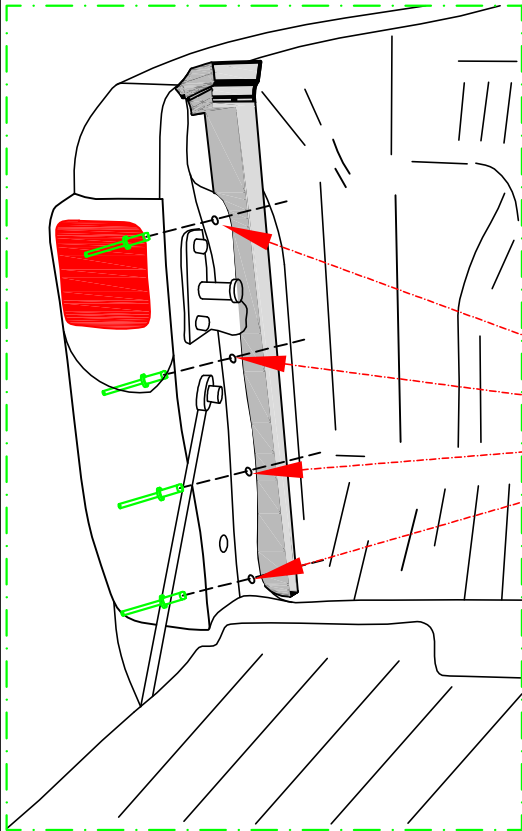
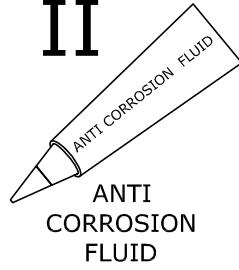

III

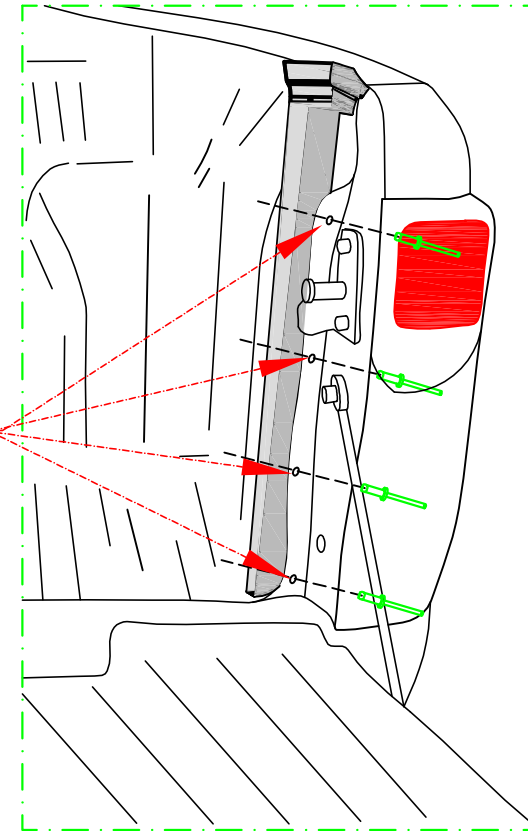
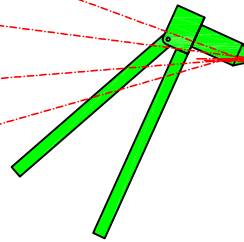

x8

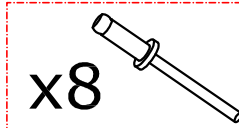

Montageanleitung >> Инструкция по установке >>

Montageanleitung >> Инструкция по установке >>

Installation instruction >> Instructions de montage >> Istruzioni di montaggio >> Instrucciones de montaje >> Montageanvising >> Instruções de Montagem

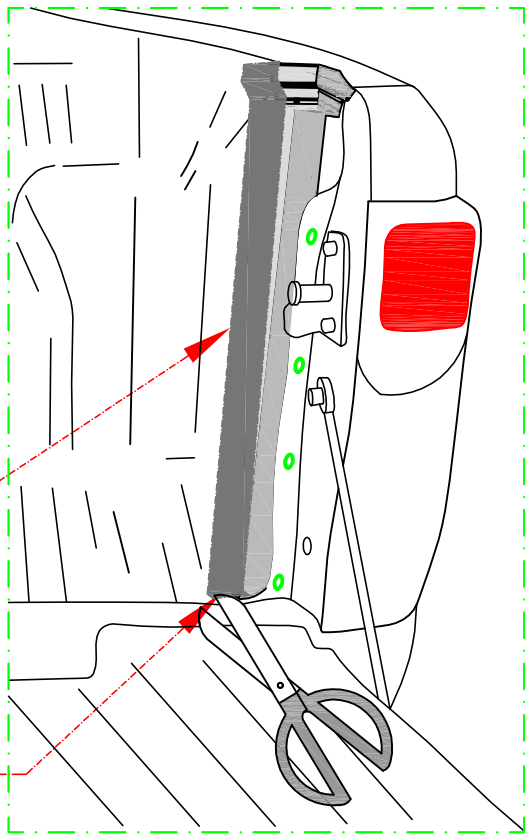
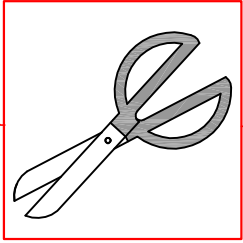
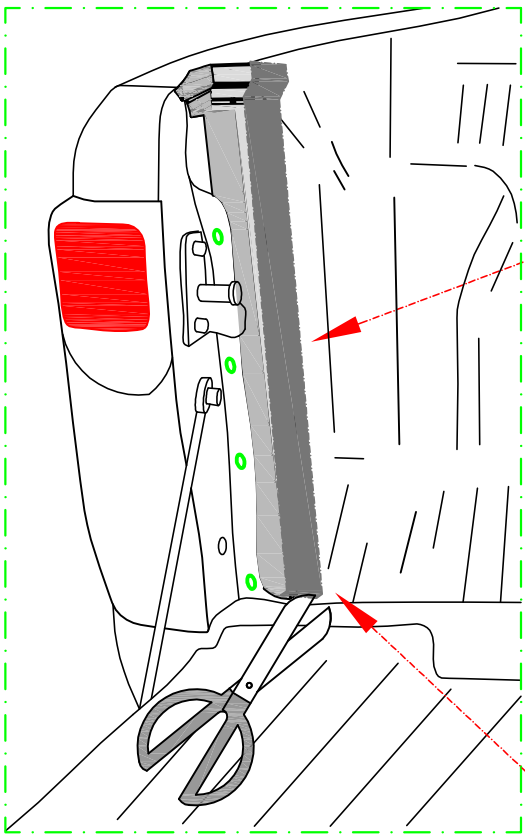
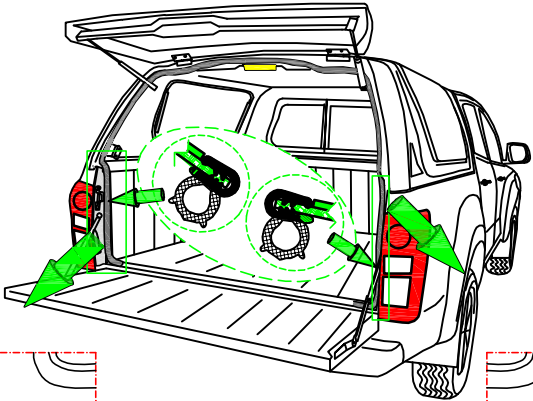
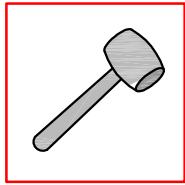
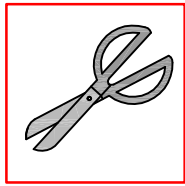
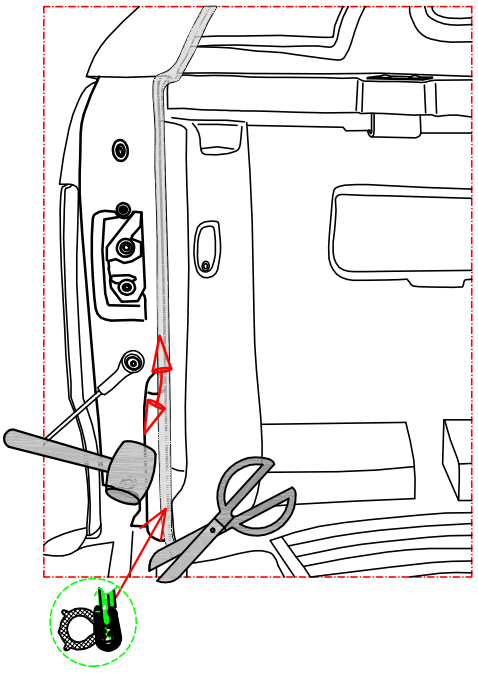

**MANUELLE ENTRIEGELUNG /
MANUAL UNLOCKING
/ OTWIERANIE KLUCZEM:**

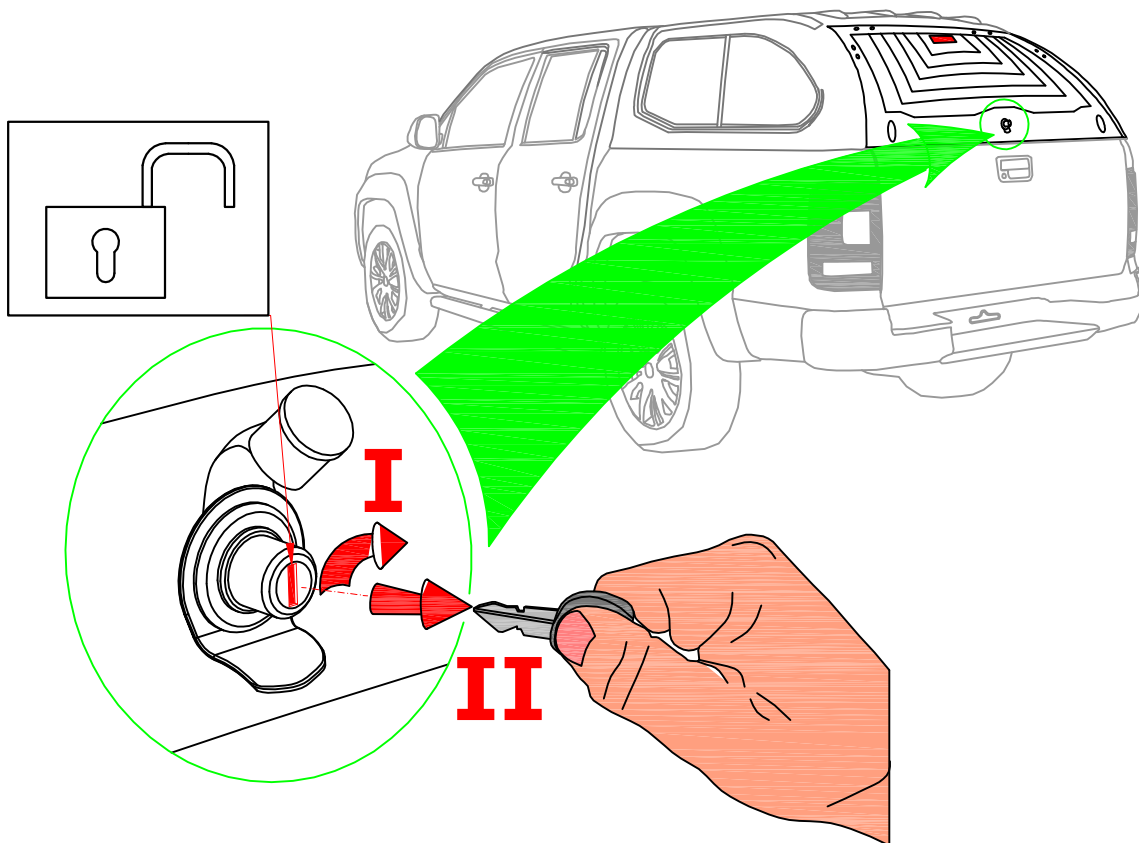

**MANUELLE VERRIEGELUNG
/ MANUAL LOCKING
/ ZAMYKANIE KLUCZEM:**

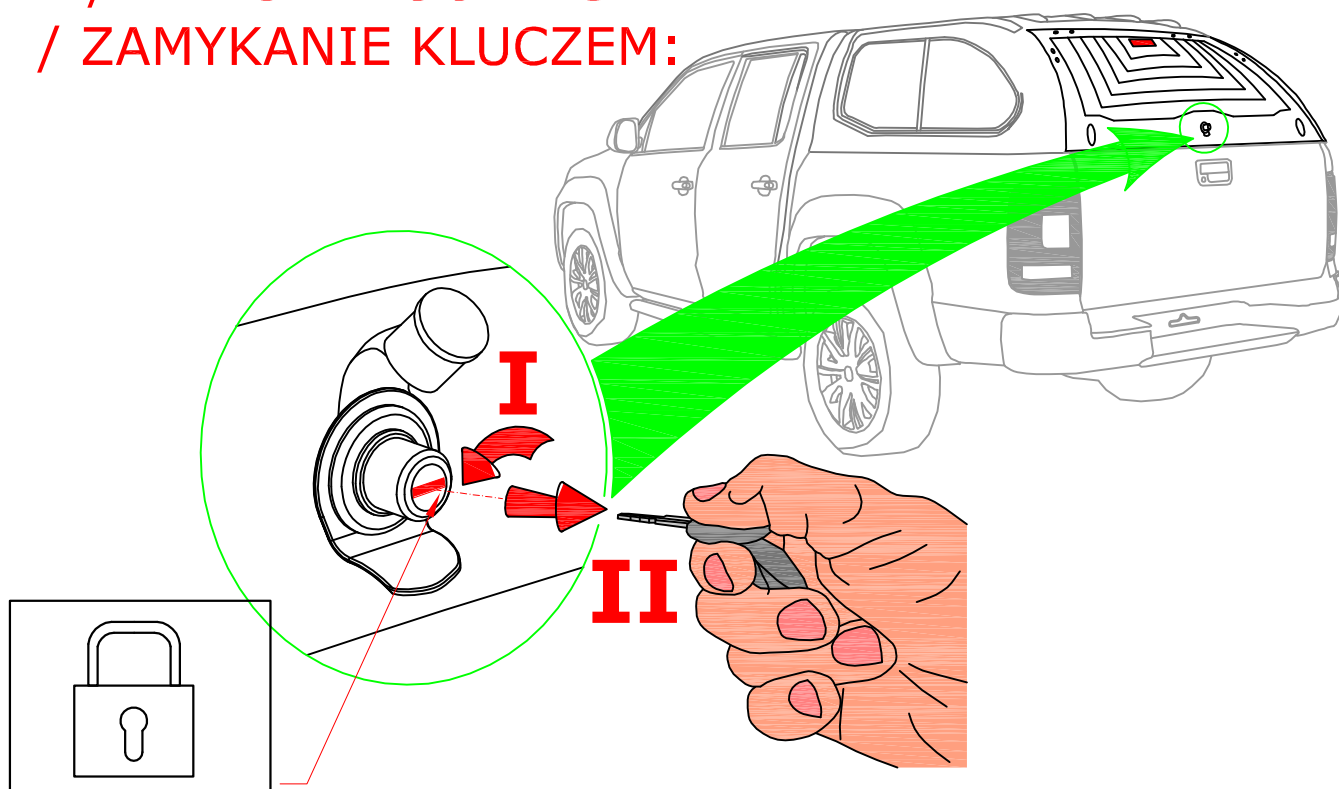

FERNENTRIEGELUNG / REMOTE CONTROL UNLOCKING / OTWIERANIE ZDALNE

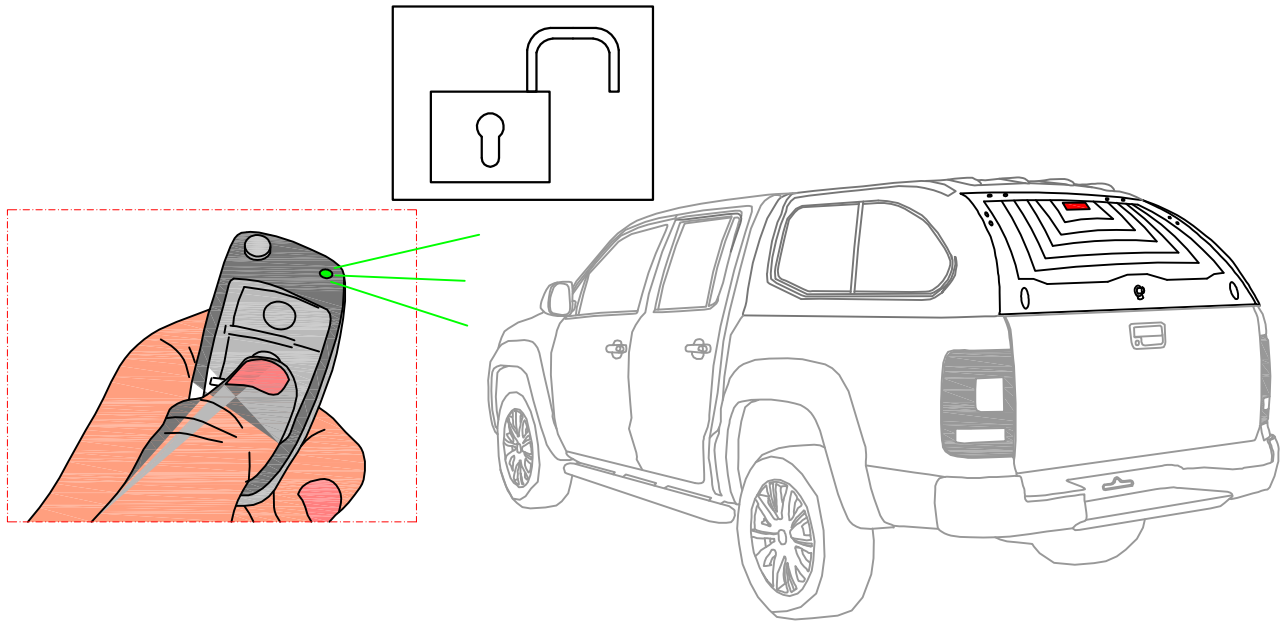

FERNVERRIEGELUNG / REMOTE CONTROL LOCKING / ZAMYKANIE ZDALNE

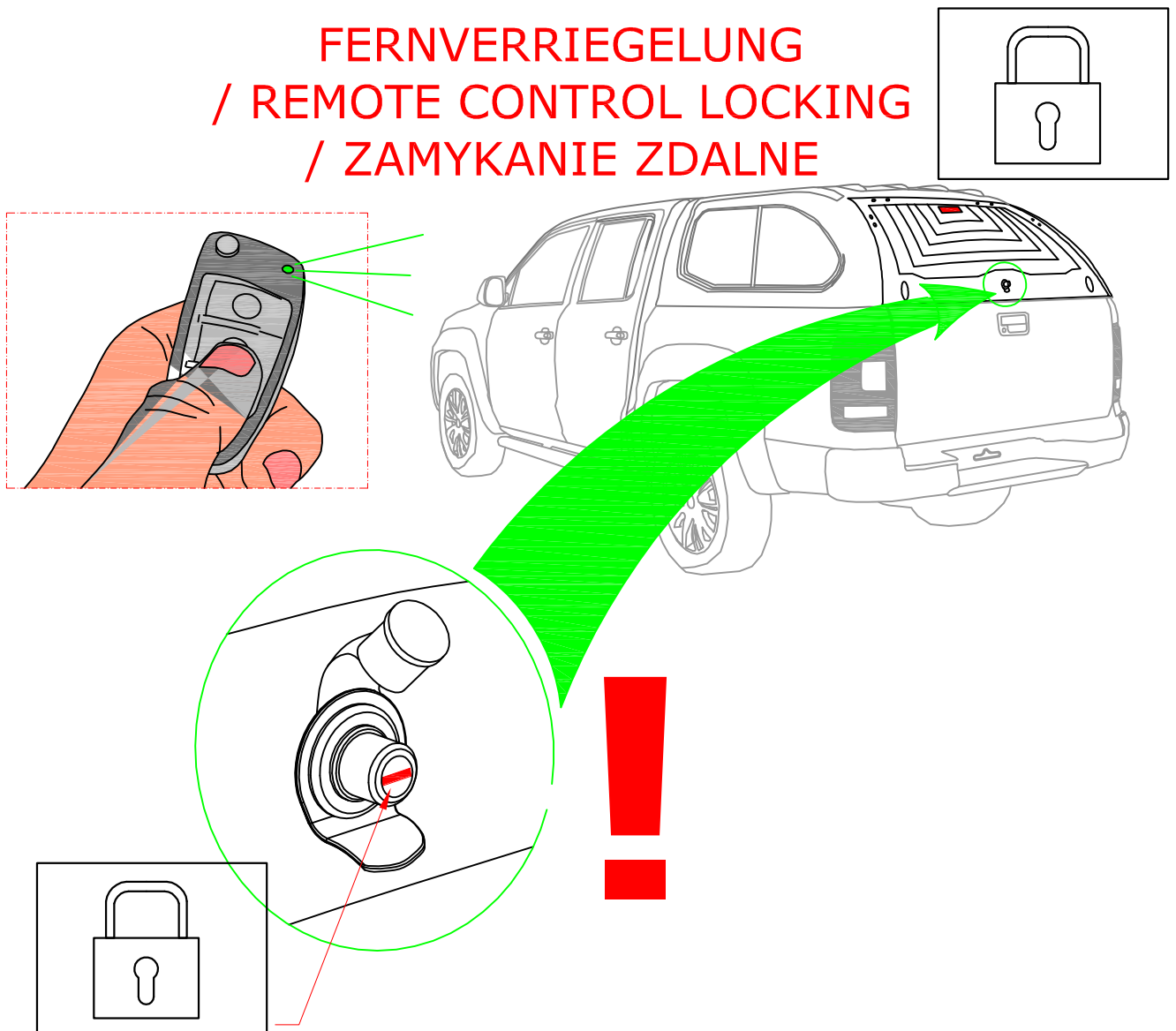

LINKE SEITENKLAPPE / LEFT SIDE DOOR / KLAPA BOCZNA LEWA

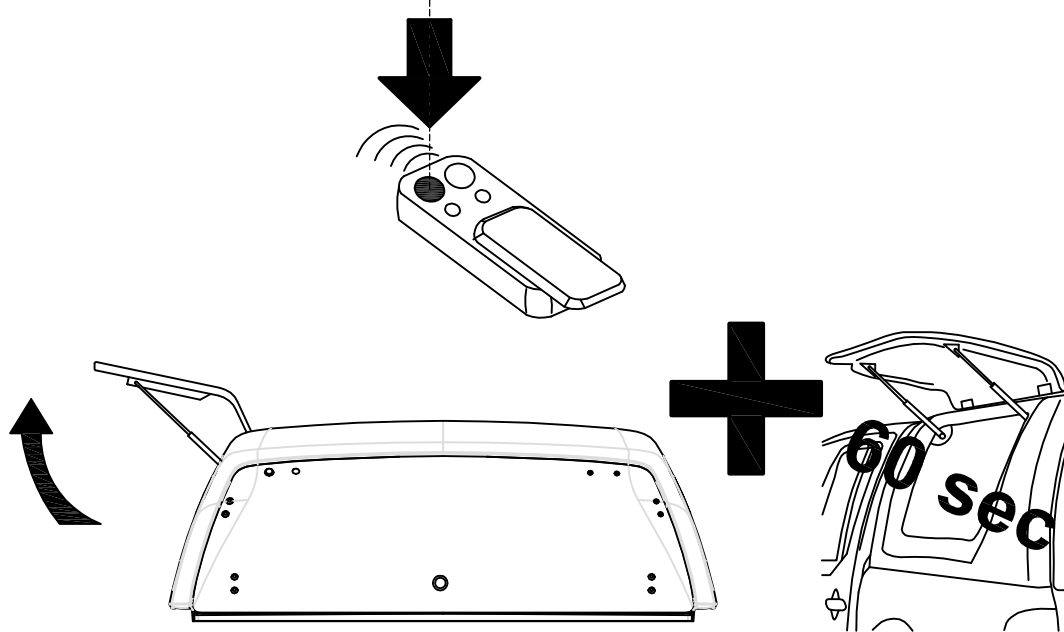

Beim oeffnen der Seitenklappe schaltet sich die Innenleuchte automatisch fuer 60 sekunden ein.
/ Press left remote controller button to open left side door and to turn on the internal light for 60 sec.
/ Przycisk ten otwiera lewą klapę boczną i jednocześnie załącza oświetlenie wewnątrz nadbudowy na 60 sek.

RECHTE SEITENKLAPPE / RIGHT SIDE DOOR / PRAWA KLAPA BOCZNA

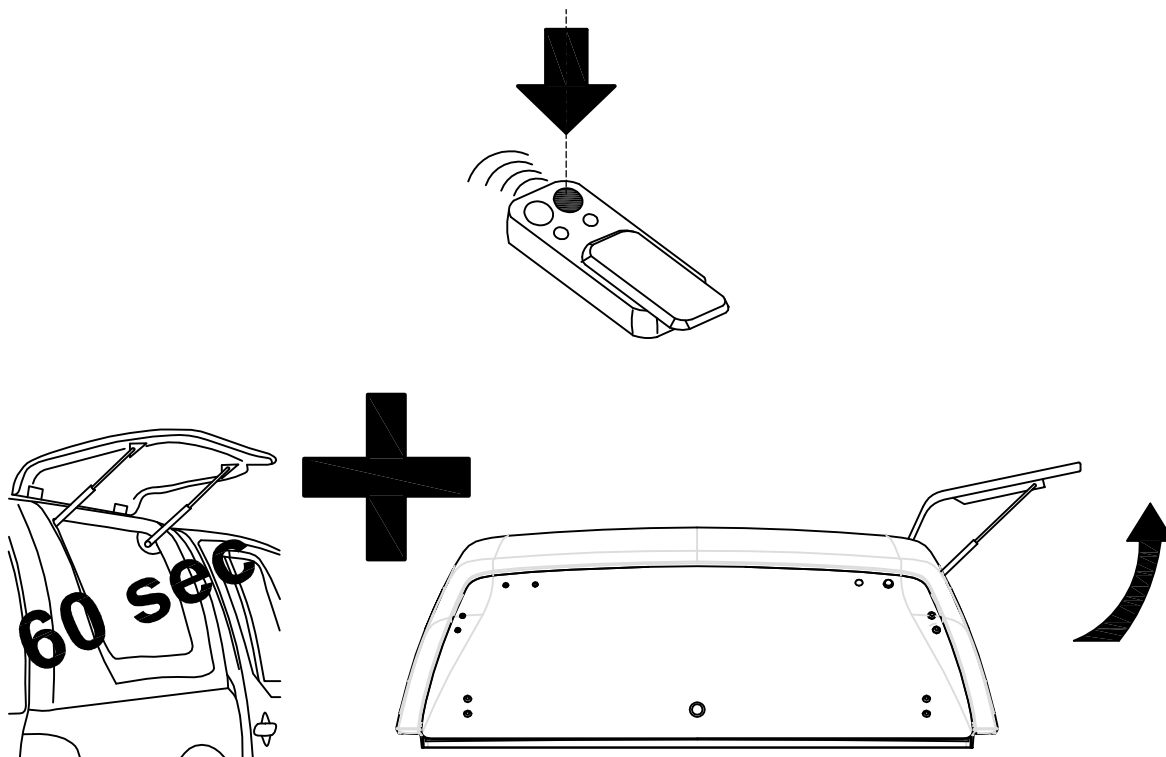

Beim oeffnen der Seitenklappe schaltet sich die Innenleuchte automatisch fuer 60 sekunden ein.
/ Press right remote controller button to open right side door and to turn on the internal light for 60 sec.
/ Przycisk ten otwiera prawą klapę boczną i jednocześnie załącza oświetlenie wewnątrz nadbudowy na ok 60 sek.

MITSUBISHI L200 >2015

*) 1900859 MI CC RH03 3 IE S2 only

Klappe - links
Sidedoor LHS

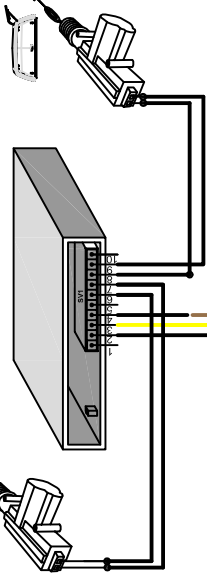

Klappe - rechts
Sidedoor RHS

Heckklappe
Backdoor/glass

SCHWERKRAFT-SENSOR-LEUCHTEN
IM INNEREN



Innenleuchte
/ Interior light

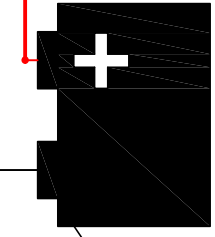
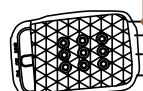

10A

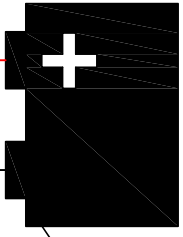

(C)

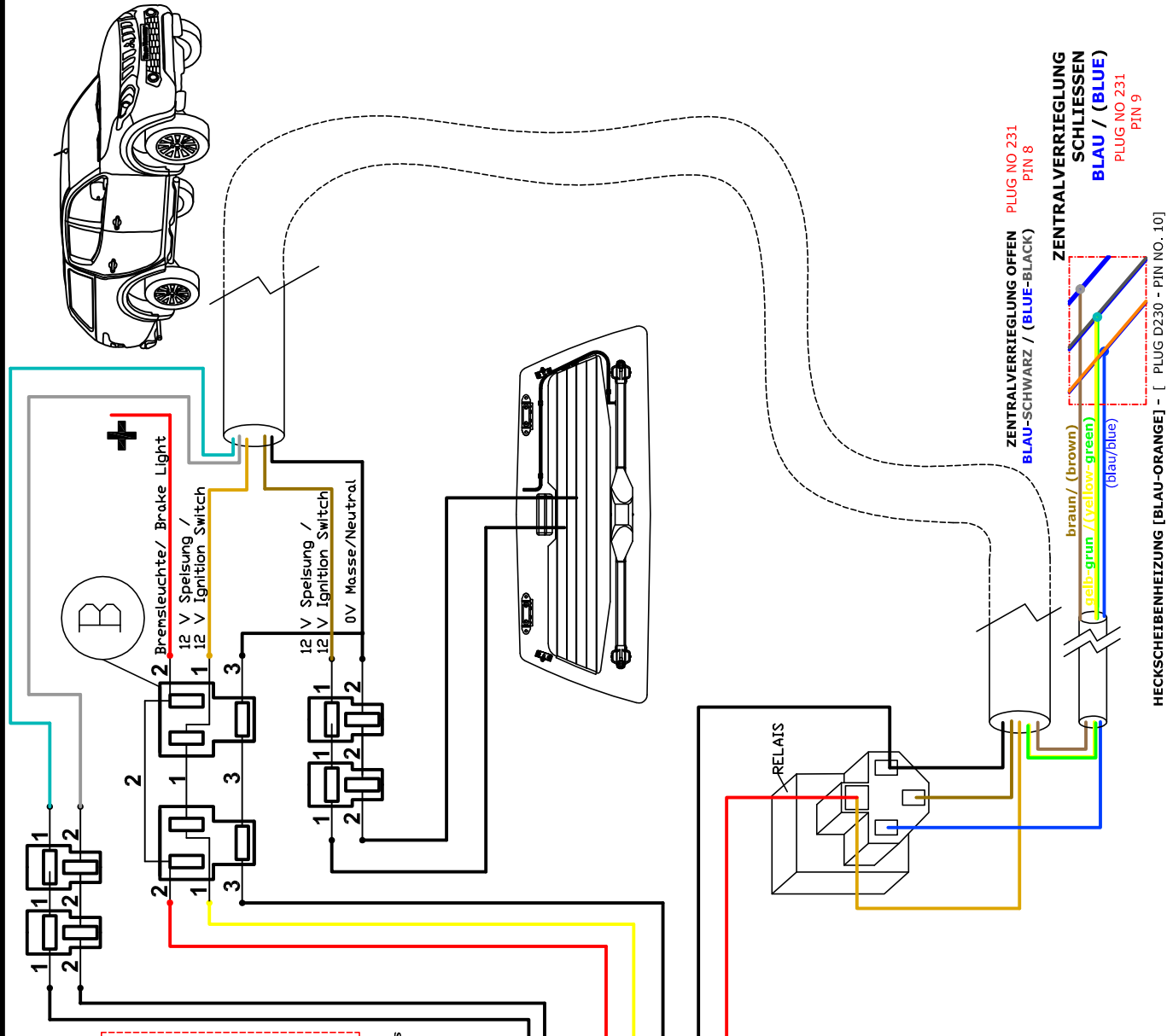

ZENTRALVERRIEGLUNG OFFEN
BLAU-SCHWARZ / (BLUE-BLACK)
PLUG NO.231
PIN 8

ZENTRALVERRIEGLUNG
SCHLIESSEN
BLAU / (BLUE)
PLUG NO.231
PIN 9

HECKSCHEIBENHEIZUNG [BLAU-ORANGE] - [PLUG D230 - PIN NO. 10]

Montageanleitung >> Инструкция по установке >>

Installation instruction >> Instructions de montage >> Istruzioni di montaggio >> Montageanvising >> Instru ções de Montagem