

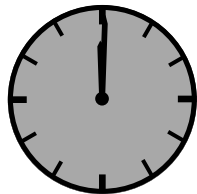

MONTAGEANLEITUNG

ASSEMBLING INSTRUCTIONS



60 Minuten



UNIVERSAL HOIST CROSSBEAM / WINDENBALKEN UNIVERSAL
WITH SAVE-LOCK / MIT SAVE-LOCK – Artikel-Nr: 11A 5133 Steel black –

Dr. Höhn GmbH
Künzelsauer Str. 13
D-74653 Ingelfingen







Phone: +49 (0) 7940 / 920241-42
Fax: +49 (0) 7940 / 920245

E-Mail: roadranger@hoehn.de
www.hoehn.de

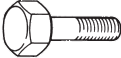
Parts list/ Teilleiste/ Lista de accesorios

1	11A5133.1	
2	11A5133.2	2x 3 11A5133.4
4	11A5133.5 R/11A5133.6 L	5 11A5133.7 R/11A5133.8 L
6	11A5133.9	7 11A5036

Standard Parts list/ Normteileliste

a		M8x20; DIN 933	26x
b		M8; DIN 934	16x
c		ø8; DIN 127	34x
d		ø8,4; DIN 9021	42x
e		SW 13mm	34x
f		M8; (Inden Nr.10070)	10x
g		W-473; cotter pin	1x

not included:
- separate -

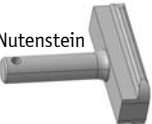
8	52 11 04 - 10	8x
	t-nut; Nutenstein	



benötigte Werkzeuge

ASSEMBLING INSTRUCTIONS: REQUIRED TOOLS

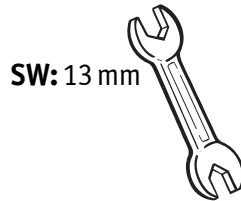

UNIVERSAL HOIST CROSSBEAM / WINDENBALKEN UNIVERSAL
WITH SAVE-LOCK / MIT SAVE-LOCK

