









ROAD RANGER®

# NISSAN NP300 NAVARA KING CAB 2016

FITTING INSTRUCTION  
H434  
MONTAGEANLEITUNG  
H434



# STÜCKLISTE PART LIST

<b>A</b>	 <b>TE M10X25</b> x 8	<b>B</b>	 <b>Ø 10</b> x 8	<b>C</b>	 <b>Ø 10</b> x 8	<b>D</b>	 <b>M10</b> x 8	<b>E</b>	 <b>M8</b> x 8
<b>F</b>	 <b>P/400/B</b> x 2	<b>G</b>	 <b>P/408/A</b> x 2	 <b>Cappelletti M10</b> x 16					

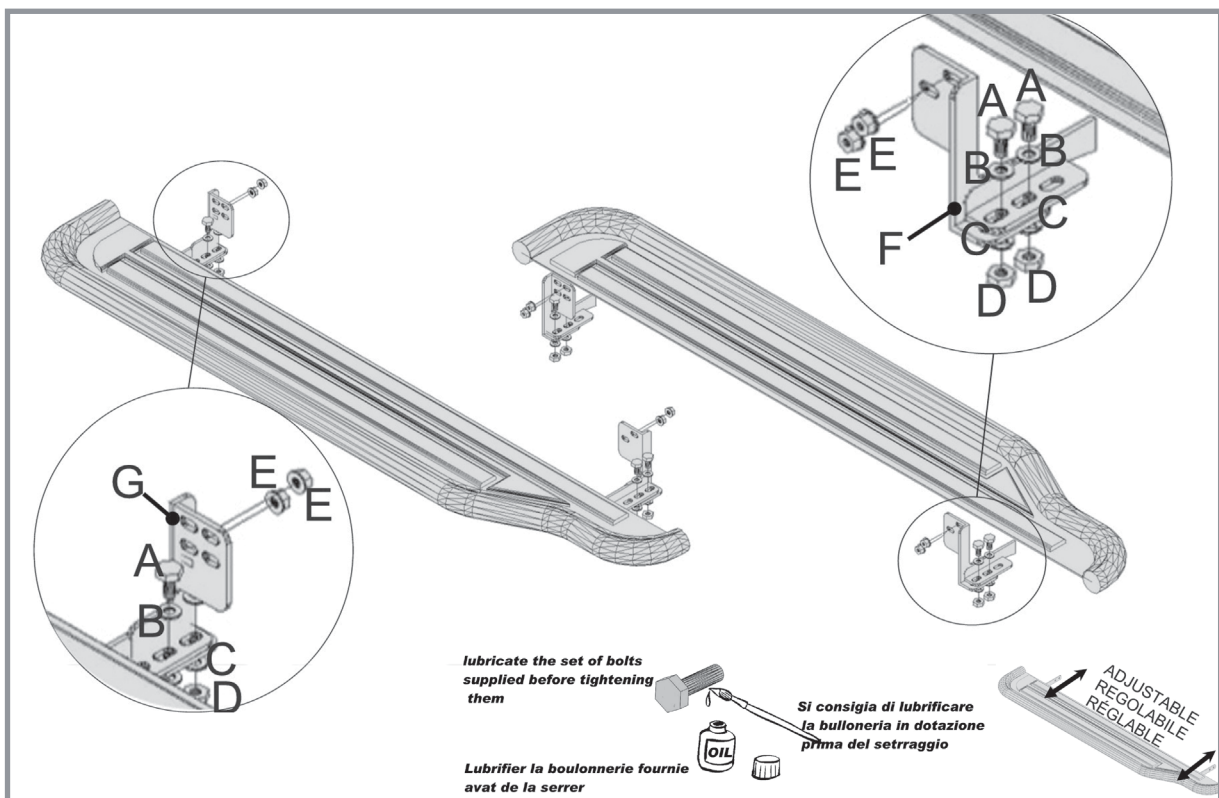
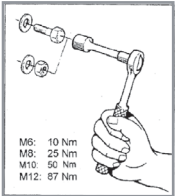

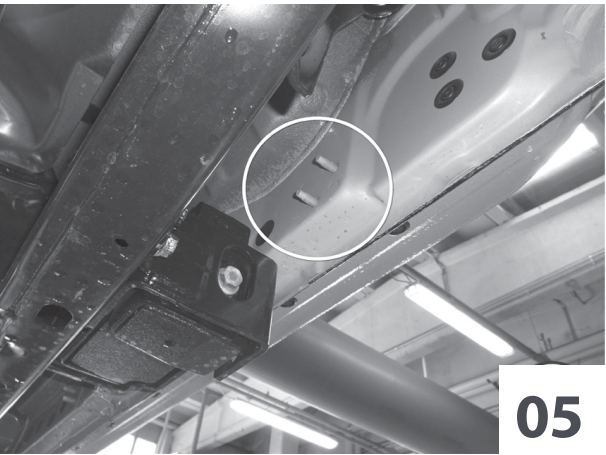
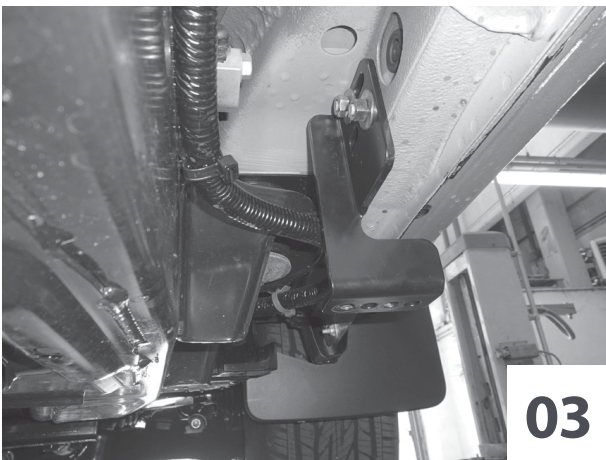
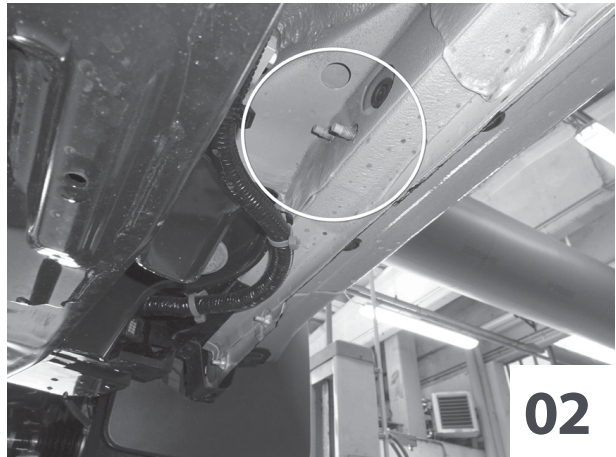

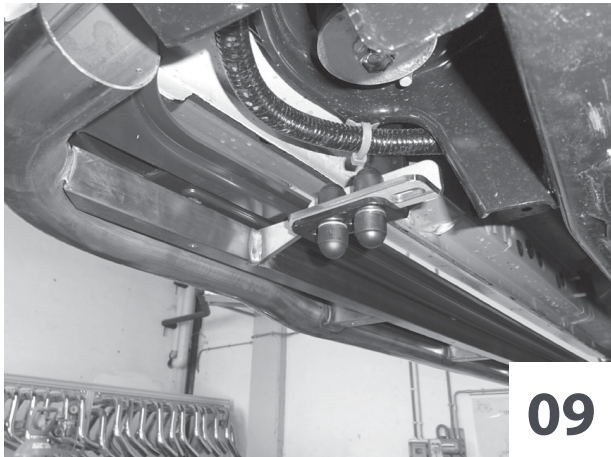
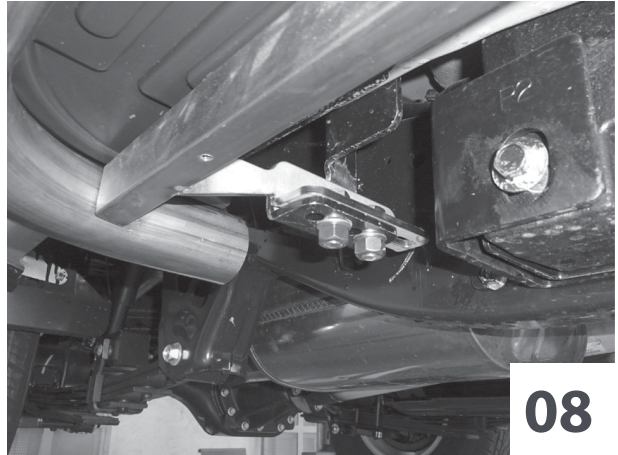
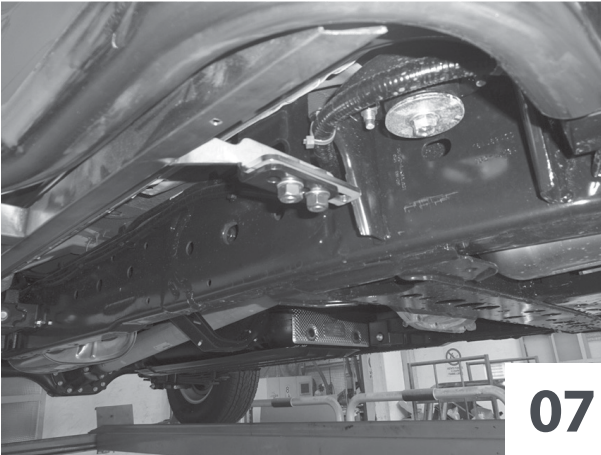

# ROAD RANGER®

## VIELSEITIGKEIT DURCH DESIGN & AUSSTATTUNG VARIETY IN DESIGN & CONFIGURATION

Änderungen vorbehalten. Abbildungen können vom endgültigen Produkt abweichen.  
Sämtliche Abbildungen / Fotos sind Eigentum der  
**Dr. Höhn GmbH**, Künzelsauer Straße 13, 74653 Ingelfingen,  
T: +49 (0) 79 40 92 02 - 0, [info@roadranger.de](mailto:info@roadranger.de)

Subject to change. Pictures may differ from the final product.  
All images / photos property of  
**Dr. Höhn GmbH**, Künzelsauer Straße 13, 74653 Ingelfingen,  
T: +49 (0) 79 40 92 02 - 0, [roadranger@hoehn.de](mailto:roadranger@hoehn.de)

Für weitere und immer aktuelle Informationen können Sie uns gerne unter  
[www.roadranger.de](http://www.roadranger.de) besuchen.

For more details and updated information please visit [www.roadranger.de](http://www.roadranger.de).

Ihr Road Ranger Team  
Your Road Ranger Team

**GESTALTUNG UND GRAFIKDESIGN**  
GRAPHIC DESIGN

christina richter visuelle kommunikation, stuttgart  
[www.christina-richter.com](http://www.christina-richter.com)