

Mountain Top Roll

Spare parts

M

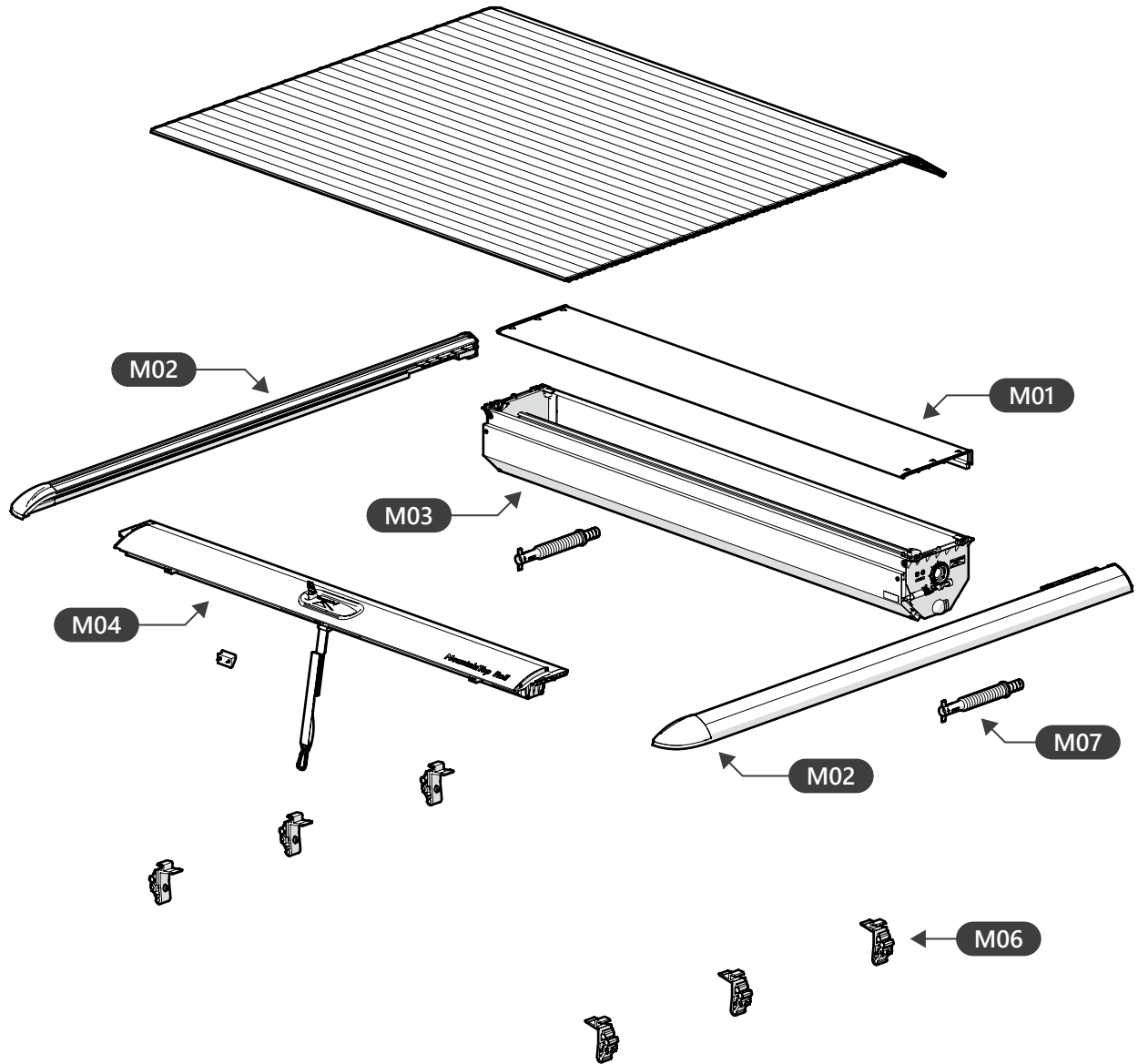

M08

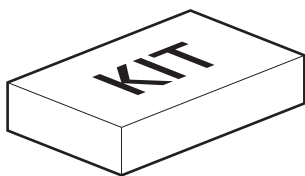

Mountain Top Roll

Spare parts

M01

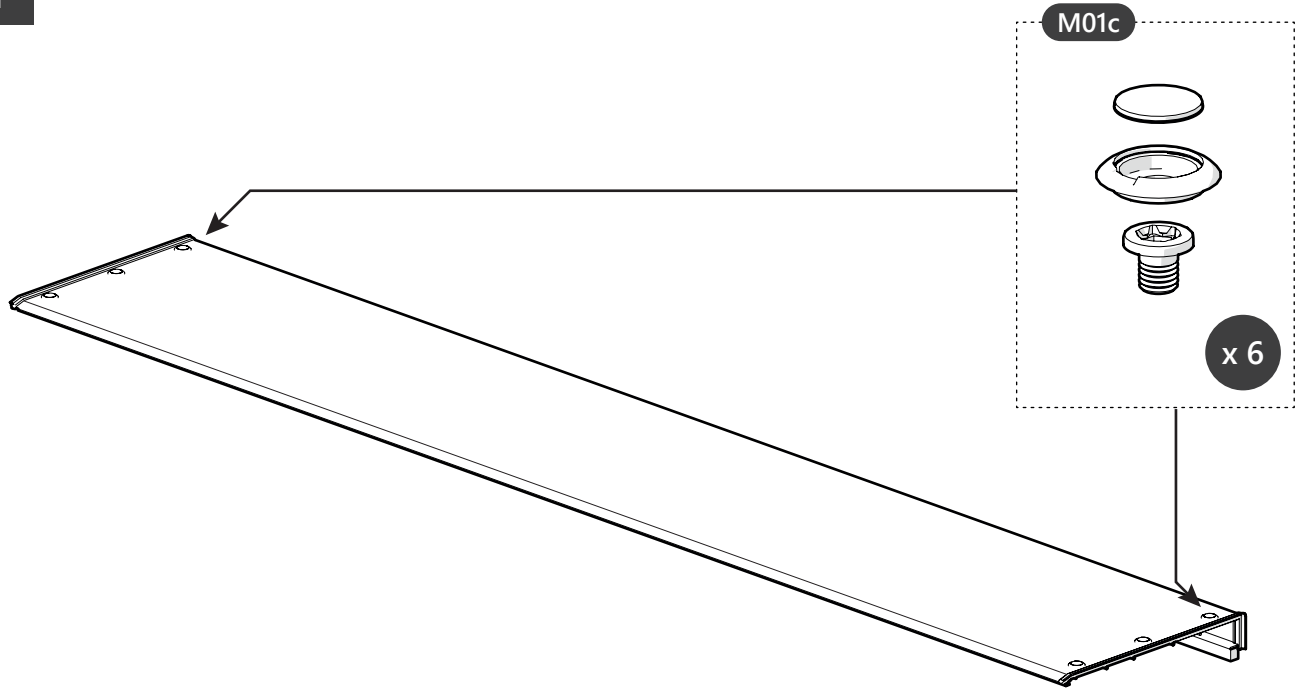

M02

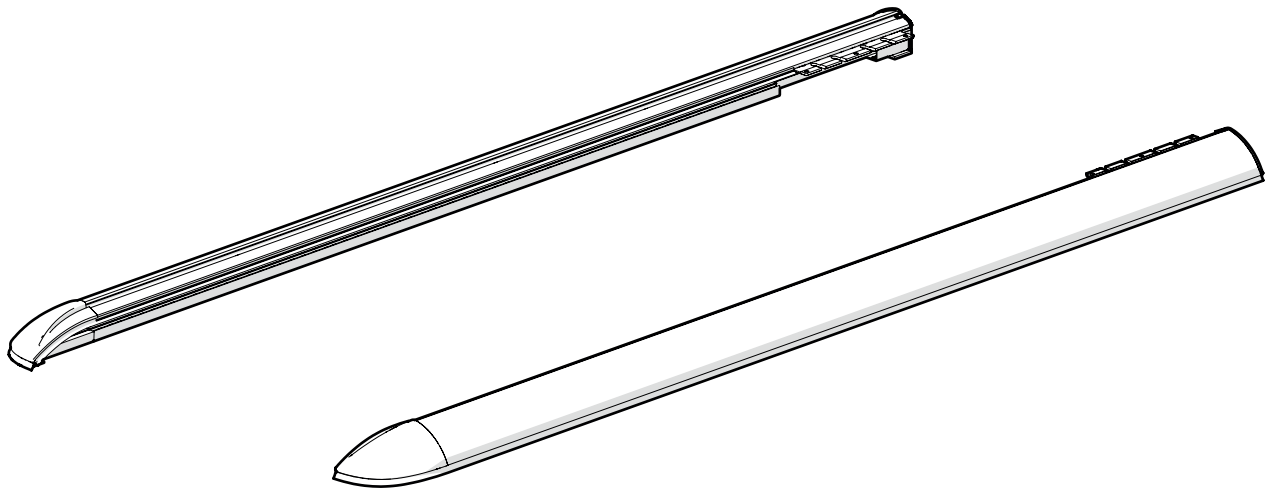

Mountain Top Roll

Spare parts

M03

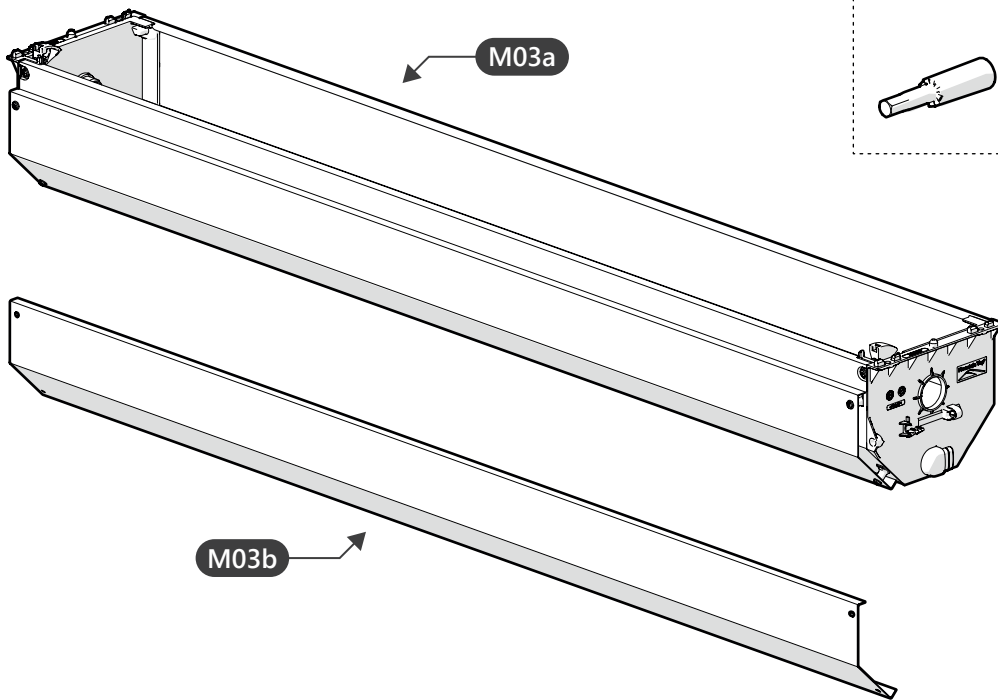

M04

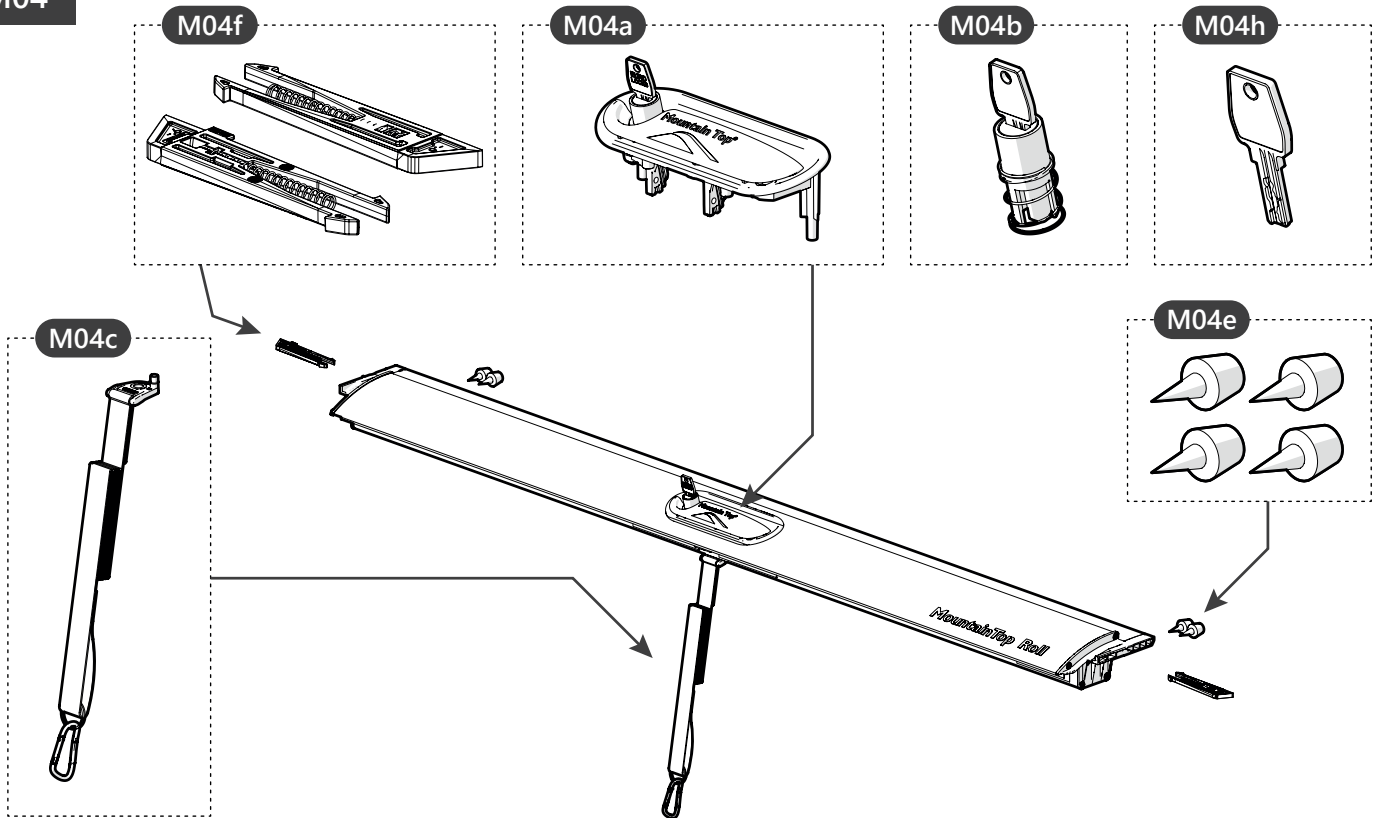



M06

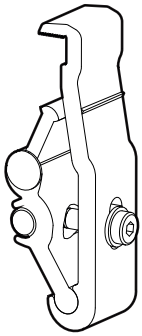

M06c x 1
FORD

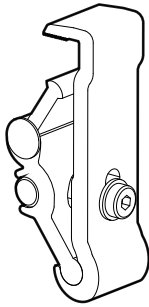

M06d x 1
TOYOTA
ISUZU

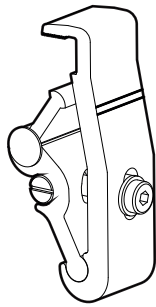

M06e x 1
VOLKSWAGEN

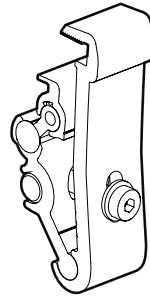

M06f x 1
NISSAN

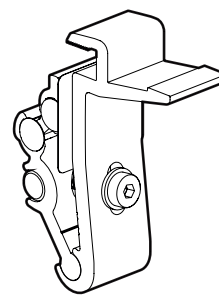

M06g x 1
TOYOTA

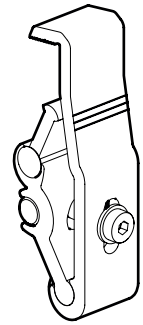

M06h x 1
MITSUBISHI

M07

M07e

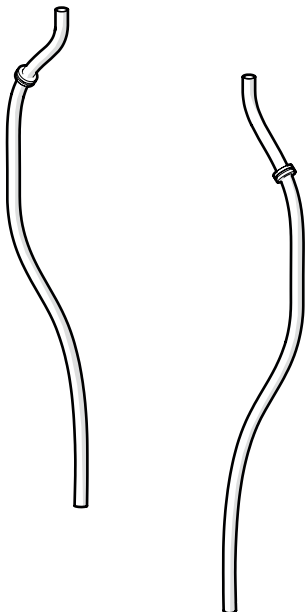

M07c

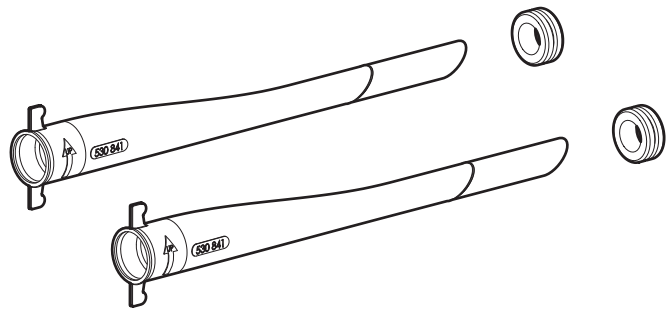

M07d

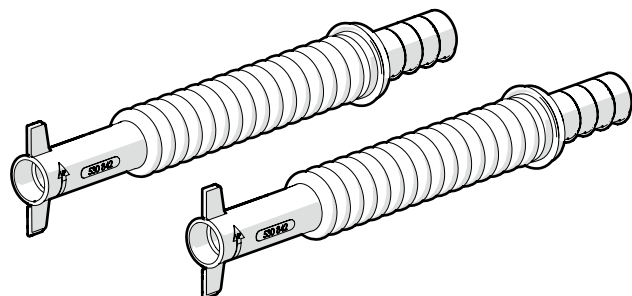

Mountain Top Roll

Spare parts

M08



x 6

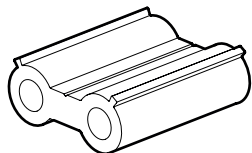

x 6

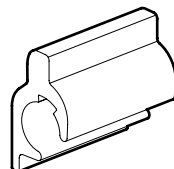

x 6

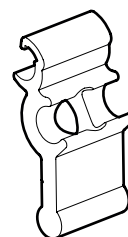

x 6

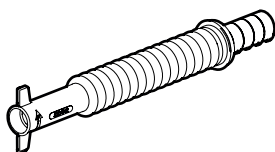

x 2

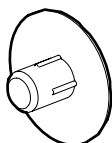

x 12 / x 24



x 6



x 6

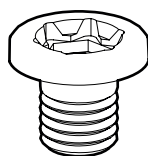

x 6

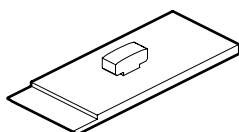

x 2

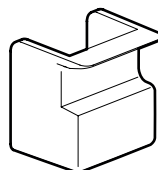

x 2

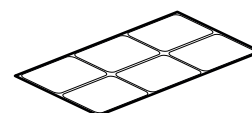

x 1

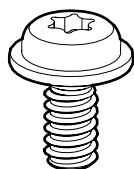

x 4

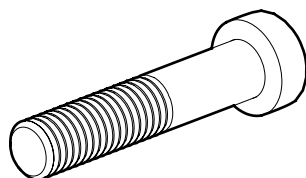

x 6

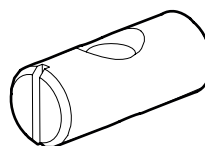

x 6



x 6

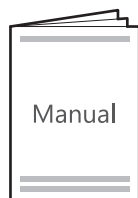

x 1



x 1



The contents of the kit may vary for different car models