

ROAD RANGER®

PICKUP-ACCESSORIES

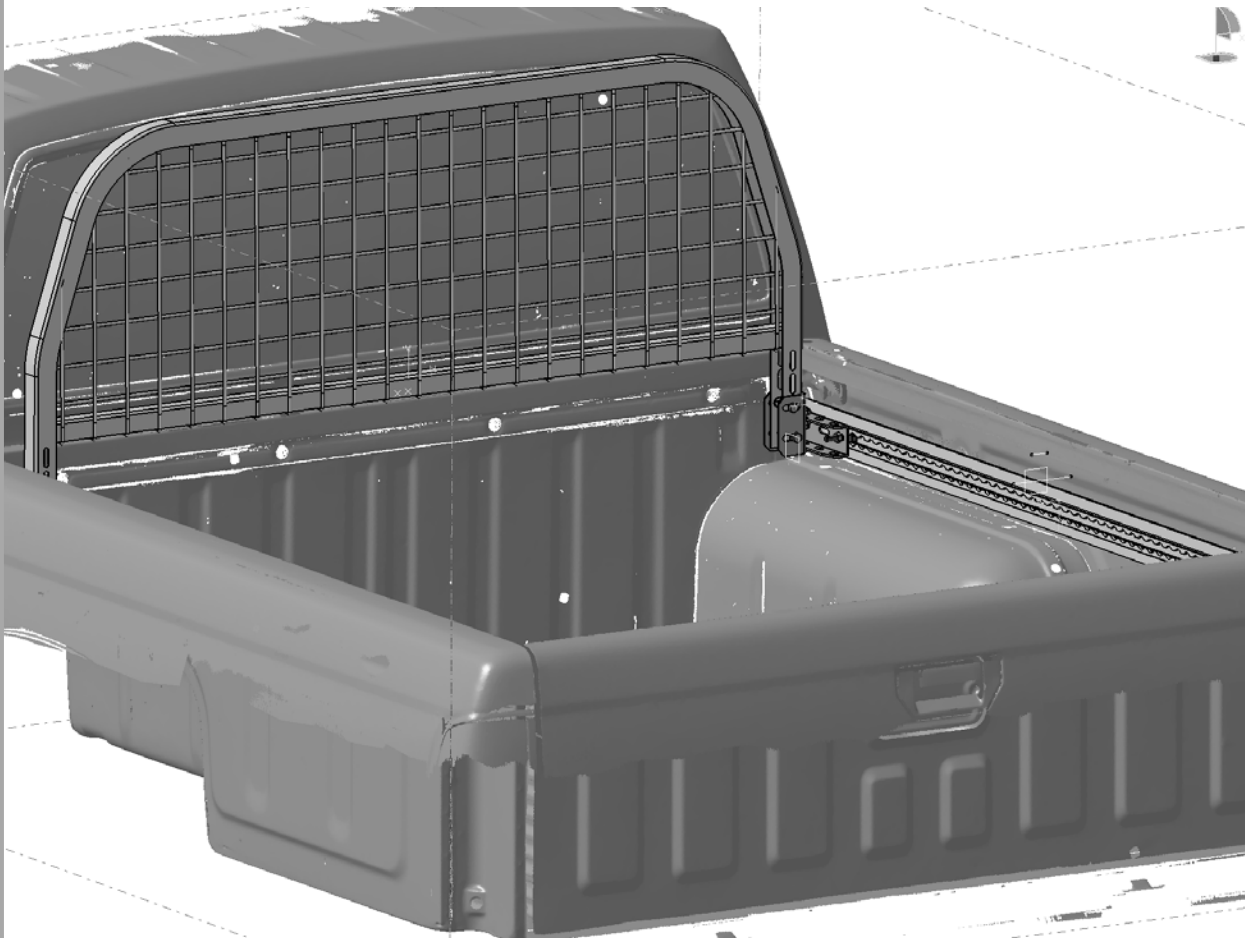

MONTAGEANLEITUNG

ASSEMBLING INSTRUCTIONS

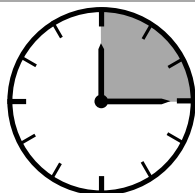

15 Minuten

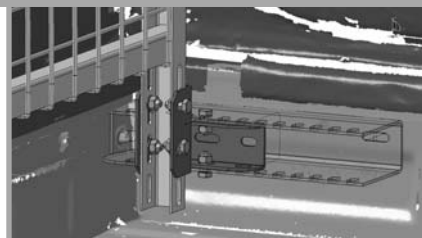

REAR WINDOW SAFETY GUARD / LADUNGSSCHUTZGITTER

- Artikel-Nr: 00 5670 Steel black • 00 5680 Steel black • 00 5690 Steel black -

Road Ranger GmbH & Co. KG
Gut Wildschaige
D-85445 Oberding

Phone: +49 (0) 8 11 - 90 57 10
Fax: +49 (0) 8 11 - 90 57 16

E-Mail: info@roadranger.de
www.roadranger.de

WWW.ROADRANGER.DE

ROAD RANGER®



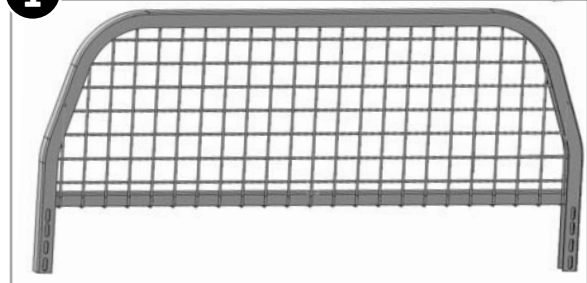

PICKUP-ACCESSORIES

Parts list/Teileliste/Lista de accesorios

1 005670.I / 005680.I / 005690.I

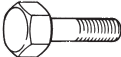

Standard Parts list/Normteileliste

a		M8x20; DIN 933	16x
b		M8; DIN 934	16x
c		Ø8; DIN 127	16x
d		Ø8,4; DIN 125	32x
e		SW 13mm	24x

Mounting set 005671 / Montagesatz 005671

2 005548 R

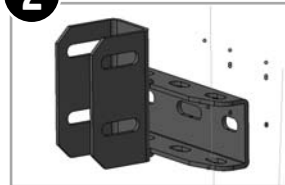

3 005549 L

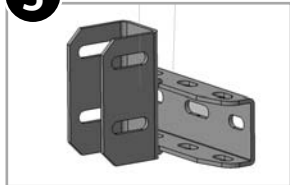

not included - separate

4 52 II 04 - 10: t-nut; Nutenstein **4x**

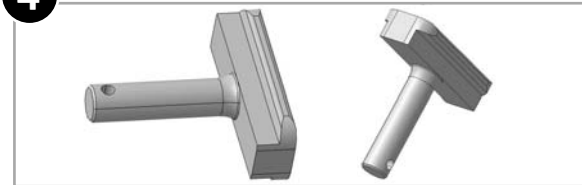

benötigte Werkzeuge

ASSEMBLING INSTRUCTIONS: REQUIRED TOOLS

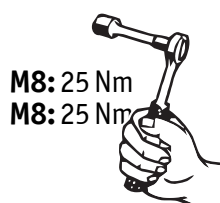
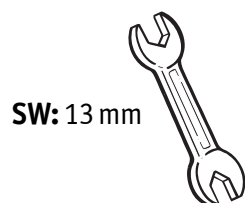

REAR WINDOW SAFETY GUARD / LADUNGSSCHUTZGITTER

- Artikel-Nr: 00 5670 Steel black • 00 5680 Steel black • 00 5690 Steel black -

Revision 2: 7.9.2010

